

SÓLAS TWENTY6 FI

CONTEMPORARY FIRE

INSTALLATION & OPERATION MANUAL

DIRECT VENT GAS FIREPLACE INSERT

This manual specifies the installation and operation requirements for the **SÓLAS TWENTY6 FI** Model Nos. FIN-36N WITH SCREEN, FIN-36P WITH SCREEN. For installation into a Masonry or Factory Built (Metal) Wood-Burning Fireplace.



WARNING:

FIRE OR EXPLOSION HAZARD

Failure to follow safety warnings exactly could result in serious injury, death, or property damage

— Do not store or use gasoline or other flammable vapors and liquids in the vicinity of this or any other appliance.

— WHAT TO DO IF YOU SMELL GAS

- Do not try to light any appliance.
- Do not touch any electrical switch; do not use any phone in your building.
- Leave the building immediately
- Immediately call your gas supplier from a neighbor's phone. Follow the gas supplier's instructions.
- If you cannot reach your gas supplier, call the fire department.

— Installation and service must be performed by a qualified installer, service agency or the gas supplier.

This appliance may be installed in an aftermarket, permanently located manufactured home (USA only) or in a mobile home, where not pro-hibited by local codes.

This appliance is for use only with the type of gas indicated on the rating plate. This appliance is not convertible for use with other gases, unless a certified conversion kit is used.



DANGER



HOT GLASS WILL CAUSE BURNS.

DO NOT TOUCH GLASS UNTIL COOLED.

NEVER ALLOW CHILDREN TO TOUCH GLASS.

A barrier designed to reduce the risk of burns from the hot viewing glass is provided with this appliance and shall be installed for the protection of children and other at-risk individuals.

Ce manuel est disponible en Français sur demande.

Tested & Listed By



OMNI-Test Laboratories, Inc.

Report #0361GN004S

INSTALLER: Leave this manual with the appliance | **CONSUMER:** Retain this manual for future reference

AVERTISSEMENT: Assurez-vous de bien suivre les instructions données dans cette notice pour réduire au minimum le risque d'incendie ou d'explosion ou pour éviter tout dommage matériel, toute blessure ou la mort.

- Ne pas entreposer ni utiliser d'essence ni d'autres vapeurs ou liquides inflammables dans le voisinage de cet appareil ou de tout autre appareil.

- QUE FAIRE SI VOUS SENTEZ UNE ODEUR DE GAZ:

- **Ne pas tenter d'allumer d'appareil.**
- **Ne touchez à aucun interrupteur. Ne pas vous servir des téléphones se trouvant dans le bâtiment où vous trouvez.**
- **Appelez immédiatement votre fournisseur de gaz depuis un voisin. Suivez les instructions du fournisseur.**
- **Si vous ne pouvez rejoindre le fournisseur de gaz, appelez le service des incendies.**

- L'installation et l'entretien doivent être assurés par un installateur ou un service d'entretien qualifié ou par le fournisseur de gaz.

Cet appareil peut être installé dans une maison préfabriquée (mobile) déjà installée à demeure si les règlements locaux le permettent.

Cet appareil doit être uniquement avec le type de gaz indiqué sur la plaque signalétique. Cet appareil ne peut être converti à d'autres gaz, sauf si une trousse de conversion est utilisée.

Ne pas utiliser cet appareil s'il a été plongé, même partiellement, dans l'eau. Appeler un technicien qualifié pour inspecter l'appareil et remplacer toute partie du système de commande et toute commande qui a été plongée dans l'eau.

Attention. Au moment de l'entretien des commandes, étiquetez tous les fils avant de les débrancher. Des erreurs de la câblage peuvent entraîner un fonctionnement inadéquat et dangereux.

S'assurer que l'appareil fonctionne adéquatement une fois l'entretien terminé.

AVERTISSEMENT. Ne pas utiliser l'appareil si le panneau frontal en verre n'est pas en place, est craqué ou brisé. Confiez le remplacement du panneau à un technicien agréé.

**INSTALLATEUR: Laissez cette notice avec l'appareil.
COMSOMMATEUR: Conservez cette notice pour consultation ultérieure.**

TABLE OF CONTENTS

IMPORTANT SAFETY INFORMATION	4
SPECIFICATIONS	5
INSTALLATION REQUIREMENTS	6
MASSACHUSETTS REQUIREMENTS	7
ASSEMBLY & INSTALLATION	9
VENTING	10
ELECTRICAL REQUIREMENT	14
GAS CONNECTION	14
LIGHTING AND OPERATION	20
MAXITROL CONTROL SYSTEM	22
GAS CONVERSION	30
MAINTENANCE	31
MAINTENANCE LOG FORM	33
REPLACEMENT PARTS LIST	34
CONTROL SCHEMATIC	33
INSTALLATION RECORD FORM	36
WARRANTY INFORMATION	37

WE STRONGLY SUGGEST THAT YOU READ THIS MANUAL THOROUGHLY BEFORE BEGINNING THE INSTALLATION OF THE TWENTY6 FI DIRECT VENT GAS FIREPLACE INSERT. ALTHOUGH THE BASIC REQUIREMENTS FOR THE INSTALLATION OF ALL DIRECT VENT GAS FIREPLACES INSERTS ARE SIMILAR, EACH SPECIFIC PRODUCT HAS ITS OWN UNIQUE SET-UP AND INSTALLATION REQUIREMENTS THAT MUST BE FOLLOWED EXACTLY. PLAN YOUR INSTALLATION IN ADVANCE BY CAREFULLY REVIEWING ALL THE INFORMATION CONTAINED IN THIS MANUAL.

IMPORTANT SAFETY INFORMATION

The installation must conform with local codes or, in the absence of local codes, with the *National Fuel Gas Code, ANSI Z223.1/NFPA 54*, or the *Natural Gas and Propane Installation Code, CSA B149.1*.

A manufactured home (USA only) or mobile home OEM installation must conform with the *Manufactured Home Construction and Safety Standard, Title 24 CFR, Part 3280* or when such a standard is not applicable, the *Standard for Manufactured Home Installations, ANSI/BCSBCS A 225.1*, or *Standard for Gas Equipped Recreational Vehicles and Mobile Housing, CSA Z240.4*.

The appliance and its appliance main gas valve must be disconnected from the gas supply piping system during any pressure testing of that system at test pressures in excess of 1/2 psi (3.5 kPa).

The appliance must be isolated from the gas supply piping system by closing its equipment shutoff valve during any pressure testing of the gas supply piping system at test pressures equal to or less than 1/2 psi (3.5 kPa).

The installation must provide for adequate ventilation air to the appliance.

This gas appliance must not be connected to a chimney flue serving a separate solid-fuel burning appliance.

The appliance, when installed, must be electrically grounded in accordance with local codes, or, in the absence of local codes, with the *National Electrical Code ANSI/NFPA 70*, or the *Canadian Electrical Code, CSA C22. 1*.

The appliance area must be kept clear and free from combustible materials, gasoline and other flammable vapors and liquids.

The flow of combustion and ventilation air must not be obstructed. Adequate accessibility clearances must be maintained for servicing and proper operation of this appliance.

Do not use this appliance if any part has been under water. Immediately call a qualified service technician to inspect the appliance and to replace any part of the control system and any gas control which has been under water.

Due to high temperatures, the appliance should be located out of traffic and away from furniture and draperies.

Children and adults should be alerted to the hazards of high surface temperatures and should stay away to avoid burns or clothing ignition.

Young children should be carefully supervised when they are in the same room as the appliance. Toddlers, young children and others may be susceptible to accidental contact burns. A physical barrier is recommended if there are at-risk individuals in the house. To restrict access to a fireplace or stove, install an adjustable safety gate to keep toddlers, young children and other at-risk individuals out of the room and away from hot surfaces.

A barrier designed to reduce the risk of burns from the hot viewing glass is provided with this appliance and shall be installed for the protection of children and other at-risk individuals.

If the barrier becomes damaged, the barrier shall be replaced with the manufacturer's barrier for this appliance.

Clothing or other flammable material should not be placed on or near the appliance.

Any screen or guard removed for servicing an appliance must be replaced prior to operating the appliance.

Installation and repair should be done by a qualified service person. The appliance should be inspected before use and at least annually by a professional service person. More frequent cleaning may be required due to excessive lint from carpeting, bedding material, etc. It is imperative that the control compartments, burners and circulating air passageways of the appliance be kept clean.

WARNING: Do not operate the appliance with the glass door assembly removed, or if the glass is cracked or broken. Replacement of the glass should be done by a qualified service person.

WARNING: Use only glass assembly, P/N 36-510 which includes the glass panel, frame and gasket. Do not use substitute materials. Do not strike or slam the glass front. Do not use abrasive cleaners. Do not clean when hot.

CAUTION: DO NOT OPERATE WITH BROKEN GLASS

SPECIFICATIONS

INPUT

	<u>Natural Gas</u>	<u>Propane (LP)</u>
Input Rating-Btu/hr	19,500	19,500
Min. Input-Btu/hr	14,000	16,000
Orifice-DMS	#46	#55

GAS SUPPLY

Manifold Pressure (H)	3.4" w.c. / 1.0kPa	10.0" w.c. / 2.5kPa
Manifold Pressure (L)	1.6" w.c. / 0.47kPa	6.0" w.c. / 1.5kPa
Min. Supply Pressure	5.5" w.c. / 1.4kPa	11.0" w.c. / 2.8kPa
Max. Supply Pressure	10.0" w.c. / 2.5kPa	13.0" w.c. / 3.3kPa

EFFICIENCY

Maximum Observed Steady State Efficiency - %	79%	80%
Steady State Efficiency - %	63.06%	65.6%
Annual Fuel Utilization Efficiency (AFUE) - %	61.63%	64.3%
Canadian p.4 Efficiency - %	59.8%	58.8%

NOTE: The maximum achievable steady state efficiency can vary depending on how the fireplace is installed and operated.

It is recommended that the pilot flame be turned off if the appliance will not be in use for an extended period of time.

This appliance is equipped for use with the fuel type indicated on the rating plate.

This appliance has been certified by OMNI-Test Laboratories, Inc. to CSA 2.33-2014 Vented Gas Fireplace Heaters and CAN/CGA-2.17-M91(R2009), Gas-Fired Appliances for Use At High Altitudes and CSA P.4.1-09.

The **TWENTY6 FI** Fireplace Insert is approved for installation at elevations up to 2000 feet in the U.S. and 1370 meters (4500 feet) in Canada without change. If your installation is at an elevation greater than these, consult with the local authority having jurisdiction for gas product installations to determine their specific requirements for high altitude installations.

OVERALL DIMENSIONS

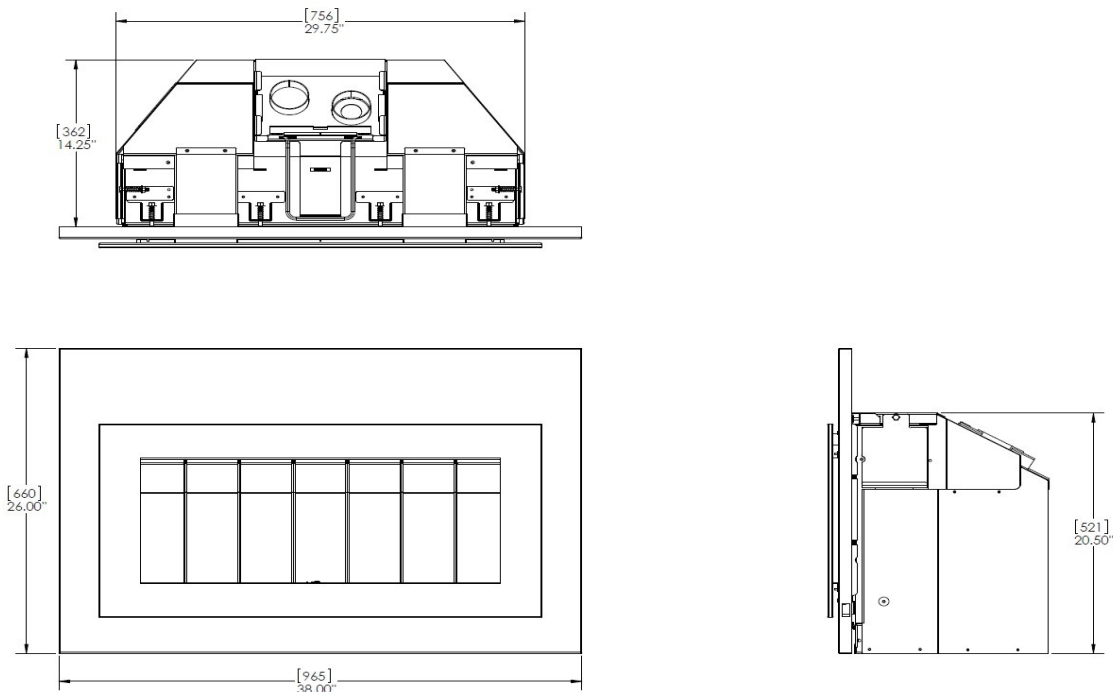

INSTALLATION REQUIREMENTS

FIREPLACE REQUIREMENTS

- Insert must be placed within a code-conforming masonry fireplace or tested and listed factory-built (metal) wood-burning fireplace. Repair any fireplace damage prior to installation.
- Because the insert uses a circulation blower, clean the fireplace, smoke shelf, and chimney prior to installation.
- This heater may be placed in a bedroom. Please be aware of the large amount of heat this appliance produces when determining a location.
- Installation and repair should be done by a qualified service person. The appliance should be inspected before use and at least annually by a professional service person. More frequent cleaning may be required due to excessive lint from carpeting, bedding material, etc. It is imperative that the control compartment, burners and circulating air passageways of the appliance be kept clean.

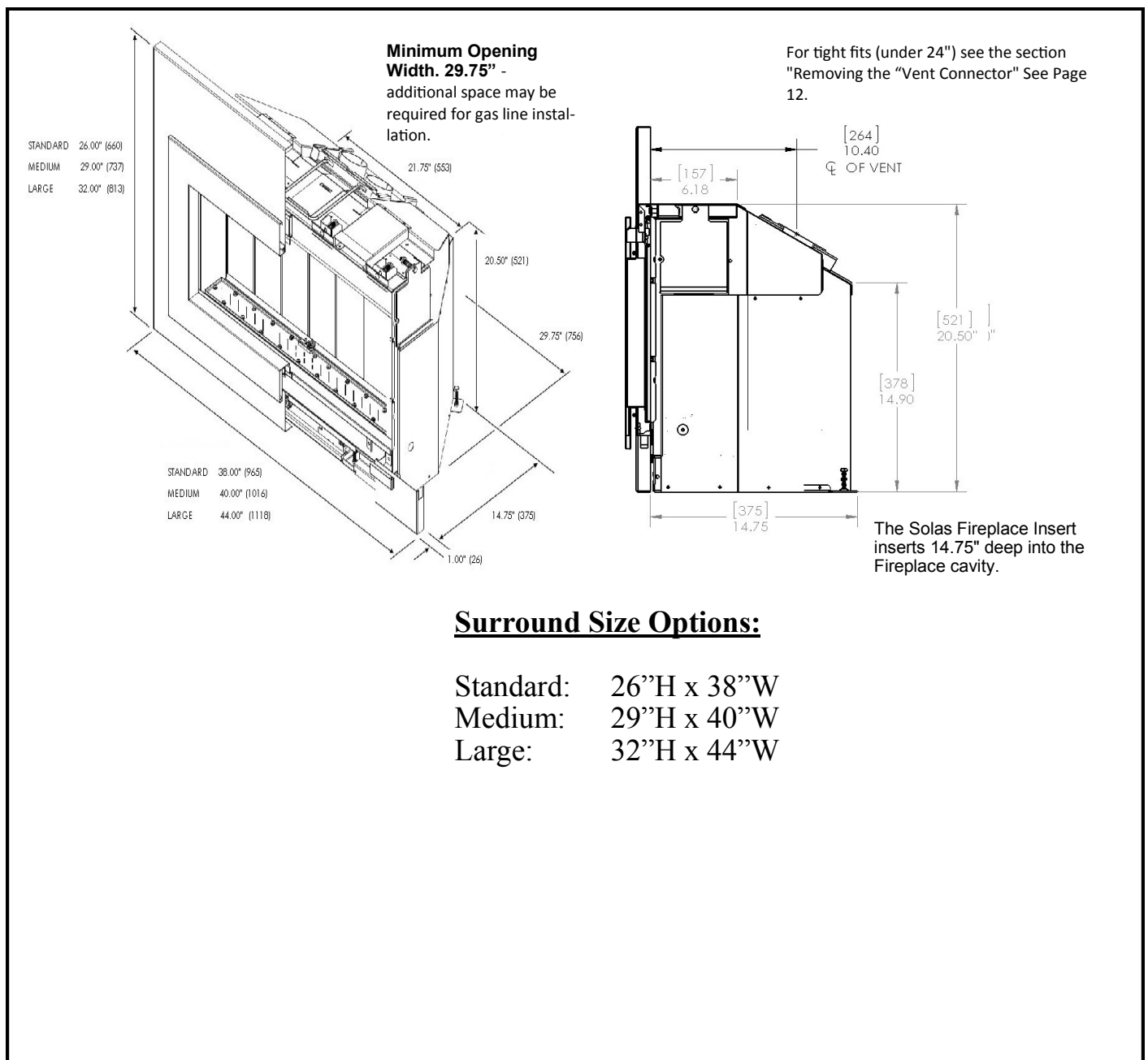

Surround Size Options:

Standard: 26"H x 38"W
Medium: 29"H x 40"W
Large: 32"H x 44"W

INSTALLATION REQUIREMENTS

Factory-Built (Metal) Wood-Burning Fireplace Requirements

NOTE: Any parts that are removed must be removed in a way that would allow them to be re-installed if the insert is ever removed (removal of rivets or screws is acceptable).

The damper ("A") and grate (with log set) ("B") must be removed (see the illustration below)

The smoke shelf ("C"), internal baffles ("D"), screen ("E"), masonry lining or refractory ("G" & "I"), and metal or glass doors ("F") may be removed if they are attached by mechanical fasteners (if applicable).

The fireplace must be permanently marked to indicate that it has been altered and is no longer suitable for burning solid fuel (wood), unless the removed parts are re-installed.

Cutting of any sheet metal parts is prohibited.

The insulation ("H"), and any structured rigid frame members must not be removed or altered (side and top of door frame, side and top of the face of the fireplace, metal sides, etc.).

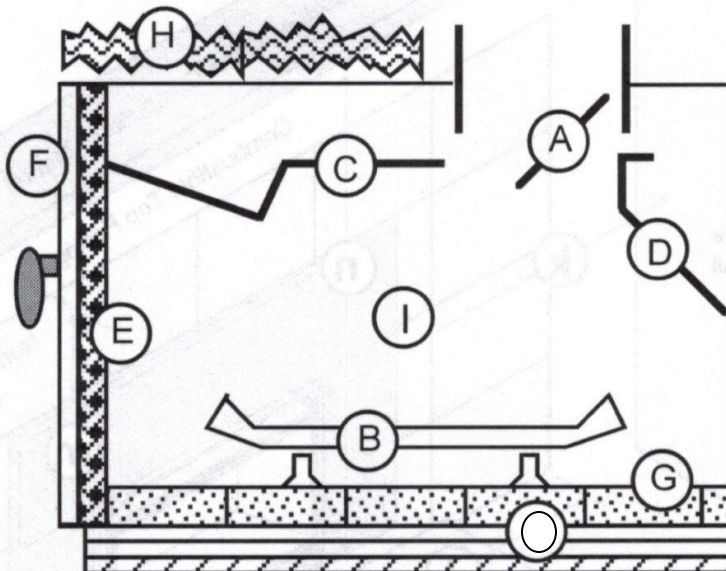

Attach the "This fireplace has been altered" tag to the fireplace (use two screws or other suitable method). You may wish to place it in a location where it will be covered by the surround panel.

MINIMUM CLEARANCES

Due to the high temperature of the heater, it should be located out of traffic and away from furniture and draperies.

Minimum Clearances

K	Sidewall to Insert	4-1/2"
I	Side Facing	4-1/2"
M	Top Facing	35" *
N	Mantel	35" *
F	To combustible Floor	1"
X	Extension onto Hearth	1"

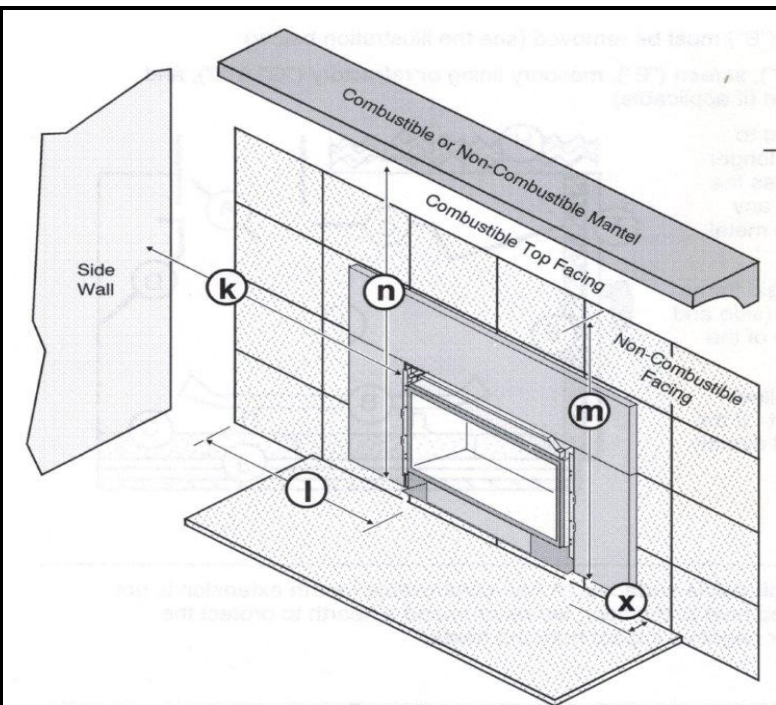

* Measured from the base of the insert.

Mantel Clearances

The maximum mantel depth is 12".

NOTE: The combustible area above the facing must not protrude more than 3/4" from the facing. If it does, it is considered a mantel and must meet the mantel requirements listed in this manual.

INSTALLATION REQUIREMENTS

Hearth Requirements

The heater and face must not contact any combustible surfaces. A minimum 1" clearance to a combustible floor is required. A non-combustible hearth extension is not required. However, if the heater is installed close to the floor, we recommend a hearth to protect the flooring surface from discoloration or other negative impacts from the heater.

The gas fireplace insert is shipped with a 3/8" stainless steel flex connector. The gas supply piping should have a separate gas shutoff valve and a 1/8" NPT plugged tapping upstream of the valve. The stove and its main control valve must be disconnected from the gas supply piping system during any pressure testing of that system at test pressures in excess of 1/2 psi (3.5 kPa). The fireplace insert must be isolated from the gas supply piping system by closing the main control valve during any pressure testing of the gas supply system at test pressures equal to or less than 1/2 psi (3.5 kPa). After the gas supply has been connected, use a commercial gas leak detector or apply a soapy water solution to all the fittings to check for gas leaks. Never use a flame to test for leaks.

REQUIREMENTS FOR THE COMMONWEALTH OF MASSACHUSETTS

This product must be installed by a licensed plumber or gas fitter when installed within the Commonwealth of Massachusetts. If this appliance is installed in a dwelling, building or structure used in whole or in part for residential purposes, a hard-wired carbon monoxide detector with an alarm and battery back-up must be installed on the floor level of the dwelling, building or structure where the appliance is to be installed.

Additionally, a hard-wired or battery operated carbon monoxide detector with an alarm must be installed on each additional level of the dwelling, building or structure served by the appliance. It shall be the responsibility of the property owner to secure the services of qualified licensed professionals for the installation of hard-wired carbon monoxide detectors.

In the event that this requirement cannot be met at the time of completion of the installation of the appliance, the owner shall have a period of thirty (30) days to comply with the requirement. However, during said thirty (30) day period, a battery operated carbon monoxide detector with alarm must be installed.

Each carbon monoxide detector as required in accordance with the above provisions must comply with NFPA 720 and be ANSI/UL 2034 and IAS certified.

In addition when the vent termination is less than seven (7) feet above finished grade a metal or plastic identification plate must be permanently mounted to the exterior of the building at a minimum height of eight (8) feet above grade directly in line with the exhaust vent terminal. The sign shall read, in print size no less than one-half (1/2) inch in size, "GAS VENT DIRECTLY BELOW. KEEP CLEAR OF ALL OBSTRUCTIONS".

Fireplace Dampers must be removed or welded in the open position prior to the installation of a fireplace insert or Gas Log.

A COPY OF THESE INSTRUCTIONS PLUS ALL VENTING INSTRUCTIONS WHICH INCLUDE PARTS LISTS, AND/OR ALL VENTING DESIGN INSTRUCTIONS MUST REMAIN WITH THE FIREPLACE AT THE COMPLETION OF THE INSTALLATION.

ATTENTION INSTALLERS: Approved with Duraflex AL - Flexible Aluminium Pipe venting system.

ASSEMBLY & INSTALLATION

WARNING: Failure to position the parts in accordance with the diagrams shown on pages 9 thru 18 of this manual, or failure to use the parts specifically approved with the appliance may result in property damage, or personal injury.

UNPACKING THE TWENTY6 FI FIREPLACE INSERT

The fireplace components are shipped in two cartons, The crate contains the fireplace insert, and the carton contains the surround you have selected. Start by opening the crate. Locate and remove the box containing the accessory items. The following items are packed in the accessory box:

- 1) Installation and operating instructions
- 2) Convection Air Ducts (x 2)
- 3) Glass Media for burner
- 4) Remote Control with batteries
- 5) "Fireplace Altered" Tag
- 6) Vent Restrictors (x 2)



Set these items to one side for use later in the installation process.

Remove the packaging materials from around the unit and unbolt the unit from the pallet.

Remove the Fireplace Insert from the pallet, and position it in front of the fireplace opening.

Finally, unpack the fireplace surround with screen from the second carton and set aside on a soft surface for later use.

VENTING

Preliminary steps to prepare for the installation of the TWENTY6 FI Fireplace Insert

Remove the chimney cap if one exists so that the flue may be cleaned and the venting installed.

Remove any existing hearth accessories such as glass doors, spark screens, andirons and grates.

Clean the chimney thoroughly to remove ash, soot, and any obstructions, and then clean ash, soot, dust and debris from the fireplace.

Chimney cleanouts must fit properly

The damper must be locked open to allow the 2 x 3" venting to pass through. If it is necessary to modify the damper area to allow passage of the venting, the modifications should be allowed under local codes. Confirm any planned changes with local building officials.

Use Only Approved Venting

Observe local codes when venting the **TWENTY6 FI** Fireplace Insert.

Please consult the installation instructions supplied by the venting manufacturer you are using. Additional brand specific installation requirements may apply, follow the installation instructions included by the venting manufacturer with the venting system components you have chosen. **The venting manufacturer's installation instructions must be followed exactly.**

Do not connect the venting to the flue of a chimney that serves a separate solid fuel burning appliance.

The most efficient venting systems are those that have a minimum number of bends and minimal horizontal runs.

WARNING: Operation of this heater when not connected to a properly installed and maintained venting system can result in carbon monoxide (CO) poisoning and possible death.

Exhaust restrictor plates must be installed depending on type of gas and chimney height. See Page 12 to determine restrictor requirements.

The fireplace and fireplace chimney must be clean and in good working order and constructed of non-combustible materials.

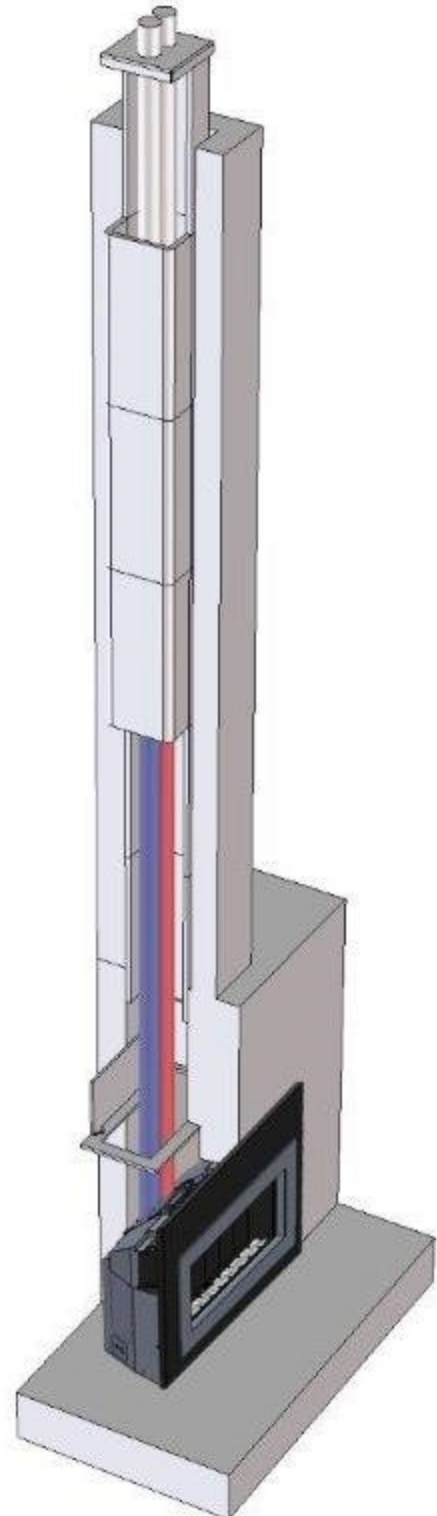

VENTING

Use Only Approved Venting

This appliance has been tested and is listed for installation with Simpson Duravent Duraflex AL venting components. The warranty will be voided, and serious fire, health, or other safety hazards may result from any of the following actions:

- Installation of any damaged Simpson Duravent component.
- Unauthorized modification of the Simpson Duravent System.
- Installation of any component part not manufactured or approved by Simpson Duravent.
- Installation other than as instructed by Simpson Duravent and the appliance manufacturer.

Consult your local building codes before beginning the installation, and follow the manufacturer's instructions exactly.

The Following Vertical Termination Caps are the only ones approved for use on this appliance:

Simpson Duravent #46DVA-VC

Selkirk Direct Temp 1604802

Amerivent Direct 4DVC

ICC ExcelDirect TM4VT

This unit is intended for Vertical Termination only. Horizontal Termination not allowed.

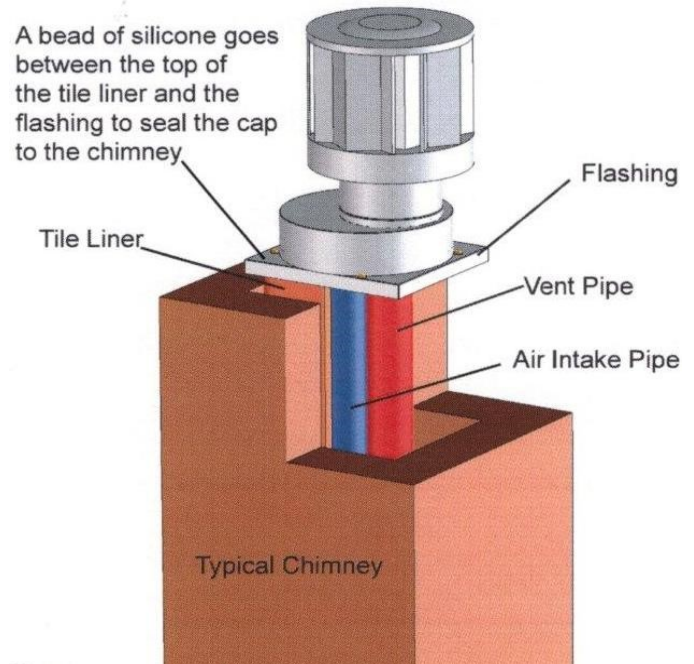

Minimum vertical vent pipe length is 10 Feet.
Maximum vertical vent pipe length is 36 Feet.
Maximum horizontal distance is 36".



Uncoil the three inch aluminum chimney liners on the ground and measure to make sure the pipes are long enough. Mark one of the liners at both ends with paint and use it for the exhaust side connection. Once they are in the chimney it allows easier identification of intake and exhaust connections.

VENTING



Feed chimney liners down the chimney and through the damper.

Position the **TWENTY6 FI** Fireplace Insert in front of the fireplace opening to prepare for Installation.

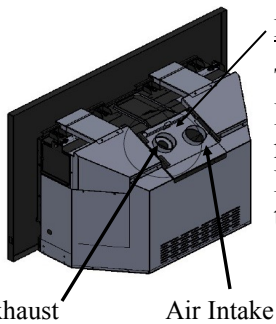

Removable Venting Connector Plate

The **TWENTY6 FI** Fireplace Insert is equipped with a removable Venting Connector Plate. Remove this plate from the unit as follows:

Exhaust Air Intake

Locate the Vent Connector Plate locking bar on the top of the unit

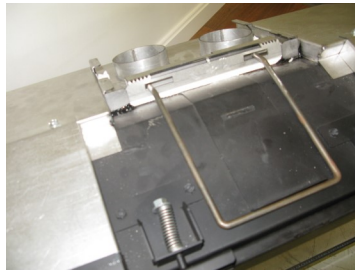

Lift up on the locking bar to release.

Push bar towards the rear, sliding the Vent Connector Plate halfway down in its locating track. At this point it will be possible to remove the plate from the fireplace insert body by lifting the plate upwards



Take care not to damage the sealing gasket affixed to the insert body.



With the Vent Connector Plate separated from the unit, attach the flex liners you have dropped into the fireplace cavity to the plate using hose clamps, making sure that the Intake and Exhaust are connected to the correct collars. Remember the exhaust liner is the one that was marked with paint earlier.

Air Intake Exhaust



Vent Restrictors

Installations with extended vent runs may experience over-drafting and require the addition of a Vent Restrictor (E or F). The best indication of over-drafting is a hyper-active flame pattern (flames that move too quickly). Over-drafting may affect the pilot, causing it to lift off the flame sensing rod shutting off the unit. Too much restriction will lead to ghosting or lifting flames - in this case less restriction is required.

The **TWENTY6 FI** Fireplace Insert is supplied with two restrictor plates and provide restriction as follows:

- No Restrictor Plate —No Restriction
- Plate "E" 1.75" diameter—Maximum Restriction
- Plate "F" 2.00" diameter. —Minimum Restriction

Determine the flue restrictor needed for this application and install into the exhaust port on the insert body.

- Natural gas uses no restrictor from 10' to 22' and the 1.75"ID (E) restrictor from 22' to 36'.
- Propane uses no restrictor for 10' to 22' and the 2.0" ID (F) for the 22' to 36' chimneys.

VENTING / INSTALLATION

If you determine that a restrictor is required in your installation, place either the “E” or “F” restrictor into the exhaust port of the fireplace insert body PRIOR to reconnecting the Vent Connector Plate to the insert body as shown:

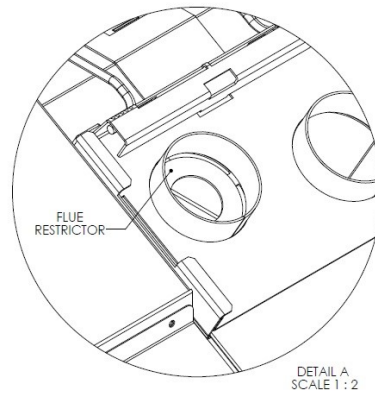
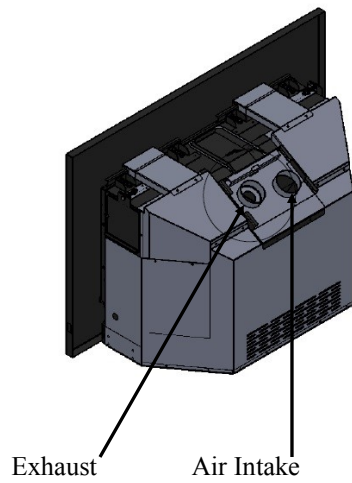
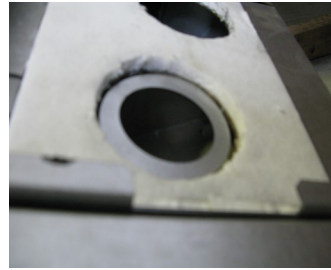

ASSEMBLY & INSTALLATION

ELECTRICAL WIRING

This fireplace insert requires 110V AC electrical supply for normal operation in order to power up the Ignition Control Module that is required to operate the Remote Control. However, during a power outage situation, its electronic system (Ignition Control) can temporarily be powered with 4 AA batteries. The convection blower will not function when the unit is operating on backup battery power.

WARNING

Electrical connections should only be performed by a qualified, licensed electrician. Main power must be off when connecting to main electrical power supply or performing service.

All wiring shall be in compliance with all local, city, and state codes, or in the absence of local codes, with the National Electrical Code ANSI/NFPA 70 (latest edition) and Canadian Electrical Code, CSA C22.1.

Caution

Label all wires before disconnecting when servicing controls. Wiring errors can cause improper and dangerous operation.

Warning

Electrical Grounding Instructions. This appliance is equipped with a three-prong (grounding) plug for your protection against shock hazard and should be plugged into a properly grounded three prong receptacle. **DO NOT CUT OR REMOVE THE GROUNDING PRONG FROM THIS PLUG.**

Always verify operation after servicing.

Gas Connection.

1. The gas line must be installed in accordance with all local codes, if any; if not, follow ANSI 223.1 and the requirements listed below.
2. Verify that the gas type is correct for the fireplace insert by looking at the rating plate that is attached to the control area of the appliance, adjacent to the control valve. Note: The fireplace insert is shipped from the factory equipped to burn the fuel listed on the rating plate. Fuel conversion in the field is not allowed.
3. The gas inlet is located on the bottom left side of the appliance. Connection should now be made from the gas supply line to the inlet flex connector on the fireplace. Use only a qualified gas installer to make the connection.
4. The fireplace is shipped from the factory with a 1/2" female flare fitting on the 3/8" flex connector.
5. The gas supply piping should have a separate gas shut-off valve and a 1/8 NPT plugged tapping upstream of the valve. We recommend installing a shut-off valve between the gas supply line where it penetrates the wall / fireplace the flex on the fireplace insert. This will allow gas to be shut-off to the fireplace by simply removing the fireplace surround to gain access to the shut-off valve.
6. The fireplace and its inlet regulator and main burner valve must be disconnected from the gas supply piping system during any pressure testing of that system at test pressures in excess of 1/2 psi (3.5kPa).
7. The fireplace must be isolated from the gas supply piping system by closing the gas shut-off valve during any pressure testing of the gas supply system at test pressures equal to or less than 1/2 psi (3.5kPa). After the gas supply has been connected, use a commercial gas leak detector or apply a soapy water solution to all the fittings to check for gas leaks. Never use a flame to test for leaks.

If the factory built fireplace has no gas access hole(s) provided, an access hole of 1.5" (37.5mm) or less may be drilled through the lower sides, or bottom of the firebox in a proper workmanship like manner. This access hole must be plugged with non-combustible insulation after the gas supply line has been installed

ASSEMBLY & INSTALLATION

Once the gas connection and electrical hook up have been complete you can start to process of connecting the venting to the insert body, and pushing the insert into the fireplace cavity.

Locate the Vent Connector Plate locking bar and pull it forward until you can align the plate with its locating track on the top of the insert body.

Take care not to damage the sealing gasket affixed to the insert body.

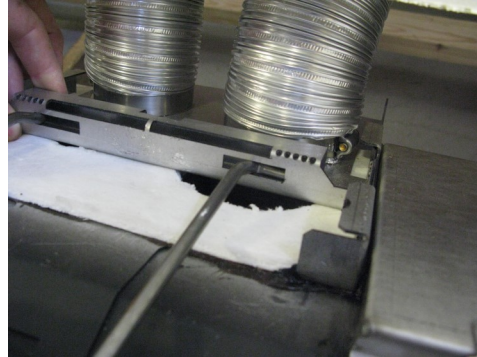

Pull the locking bar forward to fully engage the vent connector plate to the insert body.

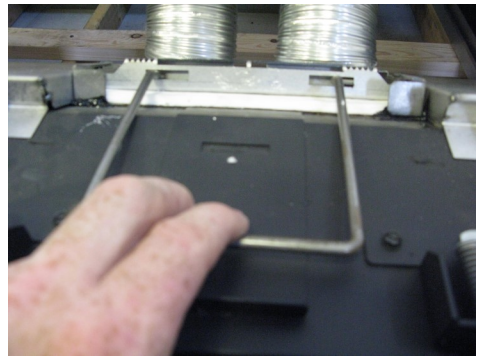

Lock the bar over the front locking tab, making sure the vent connector plate is fully engaged in its track, and sealed to the insert body.

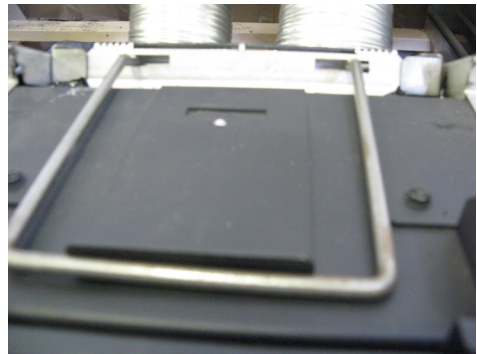

Push the fireplace insert fully into the fireplace cavity, and using the 4 leveling bolts on the unit, level the insert as necessary.

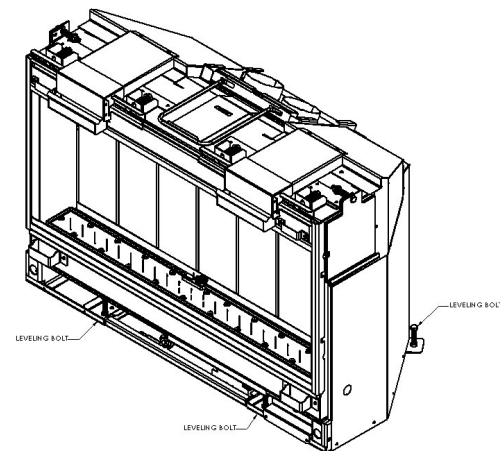

ASSEMBLY & INSTALLATION

Placing the Burner Glass Media

In order to place the glass media on the burner assembly, you will need to remove the glass front from the unit.

Glass Front removal:

The glass front is retained by four springloaded glass retaining clips.



Pull each of these clips forward, rotating 180 degrees as you do so.

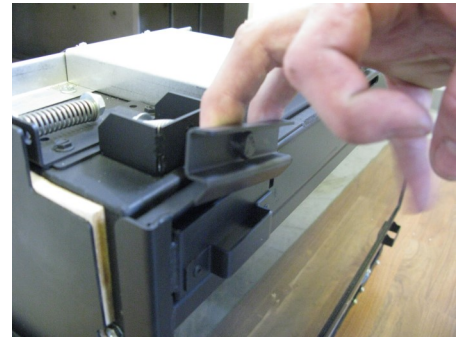

Once all four retaining clips have been released, the glass frame can be tipped forward and lifted out of the bottom retaining rail. The glass is retained in the frame with retaining tabs, so remove the glass and frame as a complete assembly. Place your thumbs on the outside of the glass frame and wrap your fingers around the frame and onto the glass. Squeeze the frame and glass while moving. Carefully lift the glass frame and glass up and off the fireplace. Set the glass and frame aside on a padded surface.



ASSEMBLY & INSTALLATION

The burner glass media poly-bag that you set aside when you unpacked the fireplace contains the correct amount of glass material to cover the burner. The entire contents of the bag should be evenly distributed over the burner tray.

1. Locate the burner in the fireplace insert. Refer to the adjacent illustration.
4. Starting at one end, pour the glass media onto the burner tray, keeping the pouring spout on the poly-bag toward the center of the burner to avoid spillage of glass pieces over the sides of the burner. See the adjacent illustrations.
5. Once you have poured all of the glass burner media into the burner tray, carefully smooth the glass pieces out so they have a uniform depth over the entire surface of the burner. When the burner glass media is properly placed, it should look like the adjacent illustrations.
6. Note: If a few pieces of glass escape over the edges of the burner tray during installation, it is not a problem. They will simply land in the area below the burner and will do no harm.



With the glass media in place, refit the front glass panel.

Carefully pick up the glass and glass frame assembly by grasping the sides of the frame and using your thumbs and fingers to hold the glass and frame as a complete assembly.

Place the bottom edge of the frame in its retaining track on the bottom of the firebox opening, centering the glass frame left to right in the track.

Then reengage the 4 spring loaded retaining clips, by pulling them forward and rotating them 180 degrees so that the bottom angled lip of each clip fully engages in its corresponding notch on the glass front.

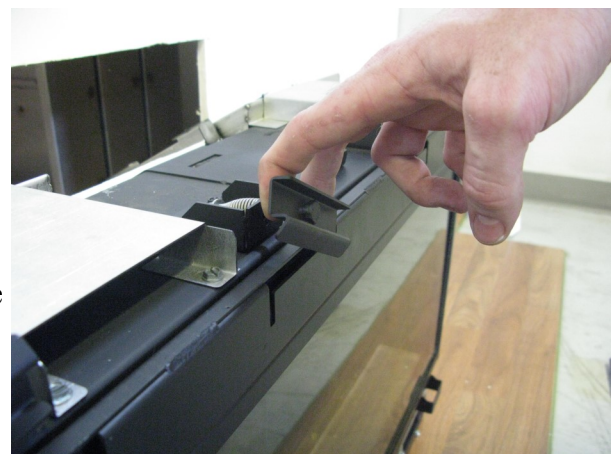

ASSEMBLY & INSTALLATION

Installing or Replacing the Batteries

1. The valve control module is powered by four “AA” batteries. The batteries are mounted within the Valve Receiver Module located underneath the fireplace, behind the surround, attached to a slide-out mounting bracket for easy accessibility.
2. Loosen the thumb screw on the module slide-out mounting bracket by turning counter-clockwise until the threads are fully disengaged from the base bracket.
3. Rotate the Valve Receiver Module and mounting bracket. Toward you 90 degrees.
4. Slide off the Battery compartment cover.
5. Install the 4 “AA” batteries, supplied, using the guides inside the battery pack to show you the correct battery orientation.
6. Replace the battery compartment cover. Rotate the Valve Receiver Module and mounting bracket into its home position and tighten the thumb screw to secure.
7. The remote handset is powered by three “AAA” batteries. The access panel is located on the back of the handset and simply snaps open to provide access to the battery compartment. Install the three batteries as shown on the label inside the remote control battery compartment
8. Replace the remote handset access panel.

ASSEMBLY & INSTALLATION

Installing Convection Air Ducts:

With the front glass panel fitted, you now need to install the two convection air ducts that were shipped in the accessory box with the fireplace insert.

Align the top of the duct with the air channel on the top of the insert.

Insert the “keyed” tabs into the slots provided on the insert front frame, and seat in place.

Only trim kit(s) supplied by the manufacturer shall be used in the installation of this appliance.

Draft relief openings must not be covered or blocked.

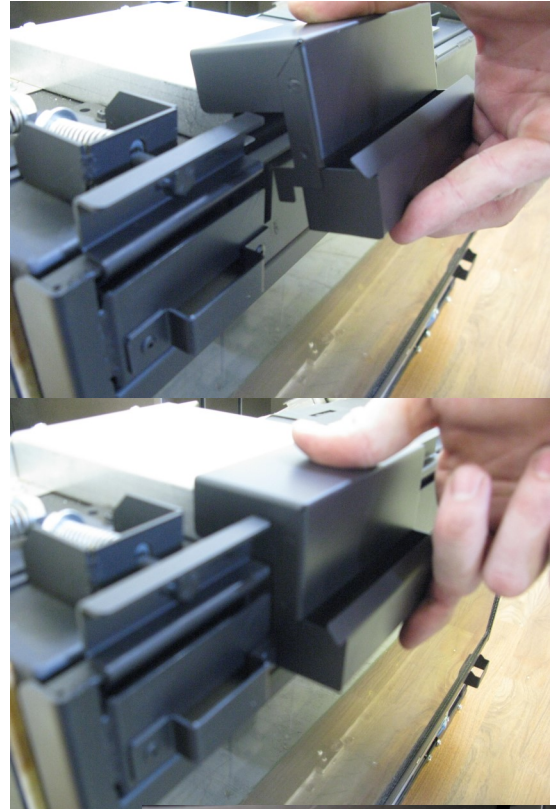

Both Convection air ducts need to be in position before the Fireplace Surround with Integrated Screen can be installed

Installing Front Face Surround with Integrated Screen:

- Locate the On/Off switch connecting cable on the back side of the Front Face.
- Locate the connection point for the switch cable on the front of the fireplace insert. Plug the cable into the connection point on the unit
- Engage the hanging hooks on the back side of the front face surround with integrated screen on the hangers located on the top left and right side and bottom left and right side of the insert.

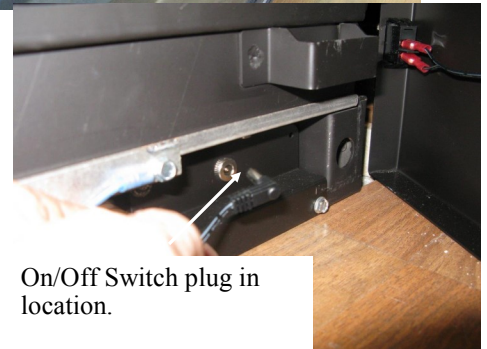

On/Off Switch plug in location.

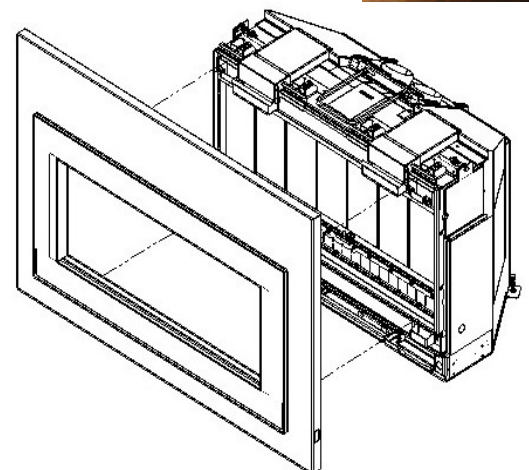
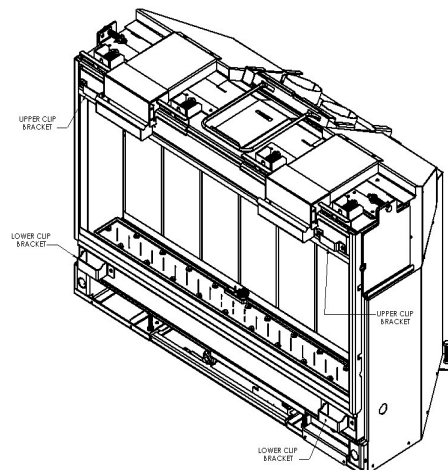
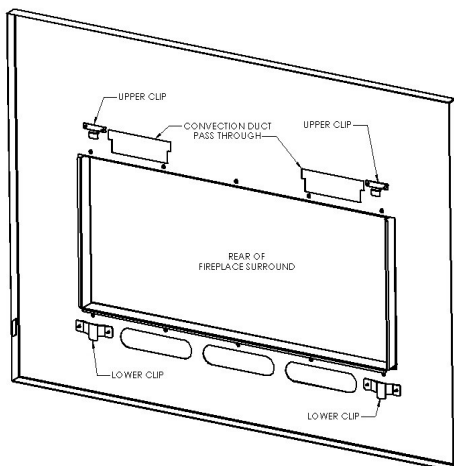

Note: The Fireplace insert surround with integrated screen shall not seal ventilation openings in the fireplace.

LIGHTING AND OPERATION

WARNING: If you do not follow these instructions exactly, a fire or explosion may result causing property damage, personal injury or loss of life.

When lighting this appliance, follow these instructions exactly.

- A. This appliance is equipped with an ignition device that automatically lights the pilot. Do not try to light the pilot by hand.
- B. BEFORE OPERATING THE BURNER SYSTEM, smell around the appliance area for gas. Be sure to smell next to the floor because some gas is heavier than air and will settle on the floor.

WHAT TO DO IF YOU SMELL GAS

- Do not try to light the appliance.
 - Do not touch any electric switch; do not use any telephone in your building.
 - Immediately call your gas supplier from a neighbor's telephone. Follow the gas supplier's instructions
 - If you cannot reach your gas supplier, call the fire department.
- C. Use only your hand to operate the gas controls. Never use tools. If a knob will not push in or turn by hand, don't try to repair it, call a qualified service technician. Force or attempted repair may result in a fire or explosion.
 - D. Do not use this appliance if any part has been under water. Immediately call a qualified service technician to inspect the appliance and to replace any part of the control system which has been under water.

OPERATING INSTRUCTIONS

1. STOP! Read the safety information above on this label.
2. This appliance is equipped with an ignition device that automatically lights the pilot. Do not try to light the pilot by hand.
3. Using the Remote Handset, or the optional Wall Switch, push the "OFF" ⏻ button until you hear an audible signal to insure the appliance is Off.
4. Wait five (5) minutes to clear out any gas. Then smell for gas including near the floor. If you smell gas, STOP! Follow "B" in the safety information above. If you don't smell gas, proceed to step 5.
5. Using either the Remote Handset, or the optional Wall Switch, simultaneously press the "ON" ⏻ and "High Flame" ⬆ buttons. An audible signal confirms the start sequence has begun.
6. Continuing beeps confirm the ignition is in process. Once lighting the pilot flame should appear as shown in Fig.2. Once the pilot is confirmed, the main burner ignites on high.

NOTE: If the pilot does not stay lit after several tries, proceed to step 9.

7. Use the flame height adjustment buttons on either the Remote Handset or the optional Wall Switch to adjust the flame. Press the ⬇ button twice to decrease the flame height to its lowest setting, press the ⬆ button twice to increase flame height to the highest setting. Pressing the ⬆ or ⬇ button once will module the flame to intermediate settings. The Remote Handset can also be used to control the appliance thermostatically.
8. Press and hold the ⬇ button on the Remote Handset or optional Wall Switch to set the appliance to Pilot flame only.
9. If the appliance will not operate, follow the instructions "TO TURN OFF GAS TO THE APPLIANCE" and call your gas service technician or gas supplier.

TO TURN OFF GAS TO THE APPLIANCE

1. To turn off gas to the appliance, push and release the "OFF" ⏻ button on either the Remote Handset or on the optional Wall Switch. You will hear an audible signal confirming the off setting.
2. TO TURN OFF THE GAS SUPPLY TO THE APPLIANCE, close the shut-off valve on the gas supply line to the appliance.

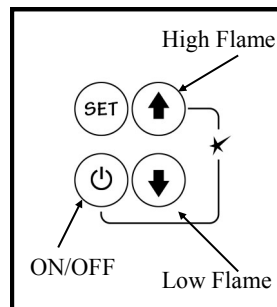

FIG. 1

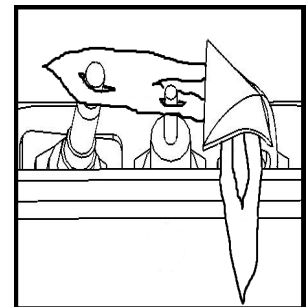

FIG. 2

LIGHTING AND OPERATION

OPERATING YOUR FIREPLACE FOR THE FIRST TIME

When operating your new fireplace for the first time, some vapors may be released due to the burning of curing compounds used in the manufacture of the appliance. They may cause a slight odor and could cause the flames to be the full height of the firebox, or even slightly higher, for the first few hours of operation.

It is also possible that these vapors could set off any smoke detection alarms in the immediate vicinity. These vapors are quite normal on new appliances. We recommend opening a window to vent the room. After a few hours use, the vapors will have disappeared and the flames will be at their normal height.

FLAME SUPERVISION DEVICE

For your safety, this appliance is fitted with a flame supervision device which will shut-off the gas supply if, for any reason, the pilot flame goes out. This device incorporates a fixed probe, which senses the heat from the pilot flame. If the probe is cool, the device will prevent any gas flow unless manually lighting the pilot. See full lighting instructions. Periodically check the pilot and the burner flame comparing them to figure 2 on page 20, and the image at the bottom of this page.

LIGHTING, OPERATION AND RATING INFORMATION

The Lighting, Operation and Rating information is located on a plate under the firebox.

To access the plate, remove any fret or access panel and grab the plate and slide it out to read it. There is important information on both sides of the plate.

⚠ WARNING

DO NOT ATTEMPT TO TOUCH THE DATA PLATE WHILE THE FIREPLACE IS STILL HOT!
Let the fireplace cool first before touching it.

SERVICING

If any attention is required for your appliance, contact your dealer quoting the model number. It will be helpful if the appliance's serial number can also be quoted. This number is on the rating plate, which is located under the burner. The replacement parts are shown at the end of this manual. Please always quote the part number and description when requesting spare parts.

FIREPLACE CONTROL DEVICES

There are two ways to control your fireplace.

1. Thermostatic Remote Control
2. Optional Wall Switch

The Thermostatic Remote Control can be programmed to function automatically—see pages 9–13.

The Wall Switch (optional) can be used to turn on, off and to increase or decrease the flame height—see M46-505 — Wall Switch Kit.

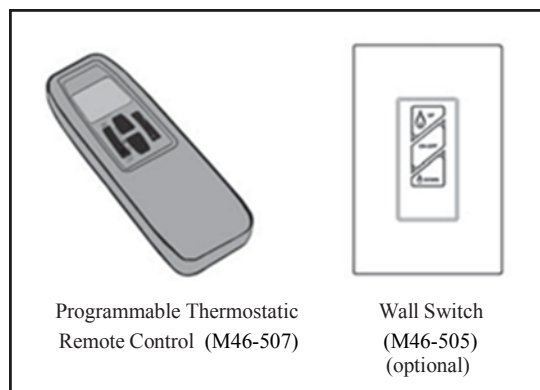

NOTE: The remote control in the AUTO mode will override the optional wall switch.



MAXITROL GV60 CONTROL SYSTEM

HOW TO TURN YOUR FIREPLACE OFF (including pilot)

Familiarize yourself with each of these methods before operating your fireplace.

Handset and Wall Switch: Press and hold the OFF button for a second (either on the handset or the wall switch).

If the flames are on, they go down and you hear the valve motor wind down. You hear a clunk and a beep indicating that the valve has received the signal from the remote control.

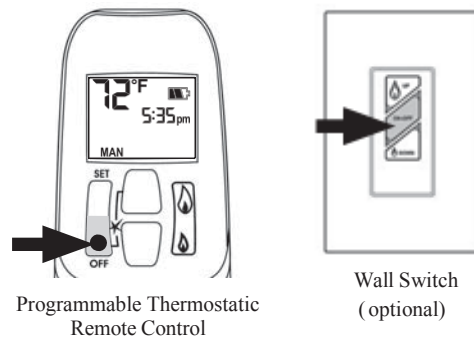

How to Ensure Your Fireplace Cannot Be Turned ON Inadvertently

You can use the following method to ensure that your fireplace will not turn on when you don't want it on.

First, ensure your fireplace is turned off—including the pilot—and cold BEFORE going ahead.

- Close the shut-off valve on the gas supply line to the appliance.
- Remove all batteries from the receiver as well as the battery from the handset.

Automatic Shut-Off (in certain conditions)

Your fireplace's remote control is equipped with an automatic shut-off mechanism which is activated in certain conditions. See page 13 in the *Remote Control Operation* section for a description of this feature.



NOTE: Before using the remote control system for the first time, the receiver and the handset are synchronized at the factory. See the section *Remote Control Initial Set-up* on page 39 of this manual if the receiver and handset lose synchronization.

IMPORTANT: BEFORE YOU BEGIN, please note that on this system, the settings of time, temperature and automatic ON/OFF can only be programmed when the function display is flashing. Be patient when programming as it can take a few seconds to set.

Maxitrol Remote Control

Please note the images of the remote handset on pages 24-28 of this manual depict the Maxitrol GV60 Remote Control, although the profile of the remote depicted is different from the one included with your fireplace, the buttons and operation of the remote is the same.

Follow the instructions in the manual using these guidelines:

-The large flame button  as seen in the manual's images is equivalent to the up arrow on your remote 



-The small flame button  as seen in the manual is equivalent to the down arrow on your remote 

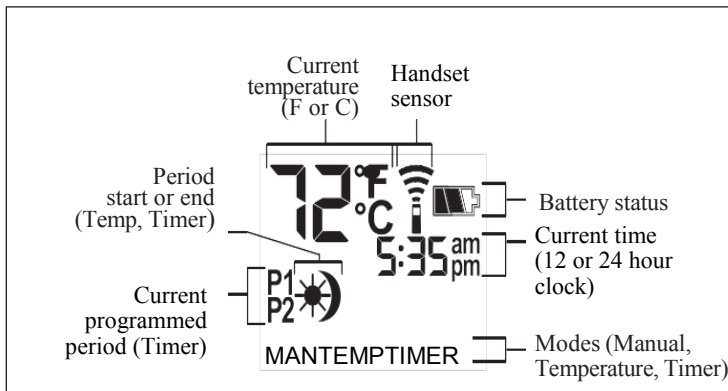

Image of the Remote Control
in the Manual



Image of the Remote Control
for your Fireplace

MAXITROL GV60 CONTROL SYSTEM



Display Overview

Note: In the TEMP or TIMER modes, the remote handset senses the room temperature and adjusts the flame accordingly.

To communicate, the handset should be within 15 feet (4.5 meters) of the fireplace.

Do not leave the handset on the hearth, mantel, or on top of the fireplace.

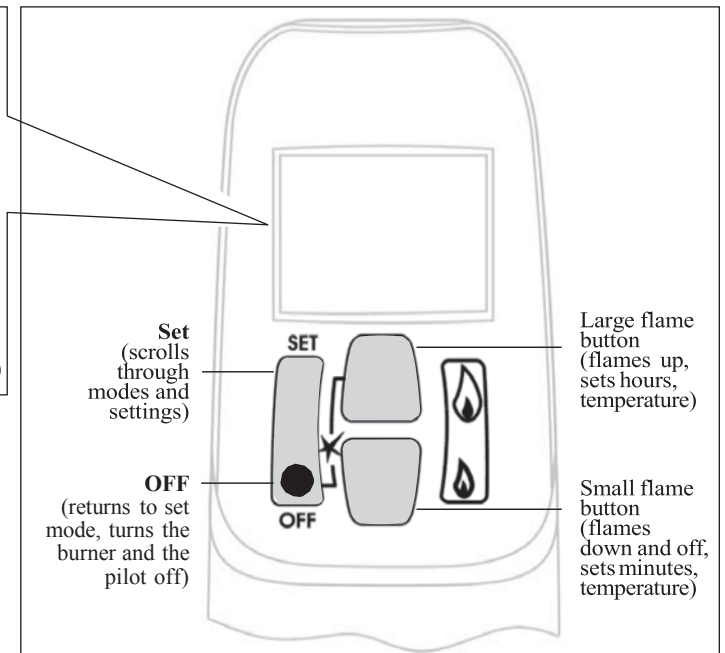

Handset Overview

TO TURN ON APPLIANCE

CAUTION

When pilot ignition is confirmed, motor turns automatically to maximum flame height.

- On the valve, turn MAN knob on the ON, full counterclockwise  position.

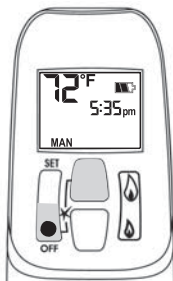

- Simultaneously press the OFF and 🔥 (large flame) buttons until a short beep confirms the start sequence has begun; release buttons.
- Continuing beeps confirm the ignition is in process.
- Once pilot ignition is confirmed, there is main gas flow.
- After main burner ignition the handset will automatically go into manual (MAN) control mode.

TO TURN OFF APPLIANCE

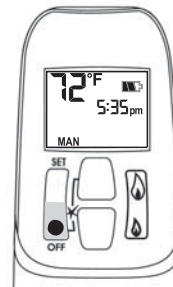

- Press OFF button.

When the pilot is off, it will take 2 minutes before it can be lit again.

STANDBY MODE (Pilot Flame)

- Press and hold 🔥 (small flame) to set appliance at pilot flame

FLAME HEIGHT ADJUSTMENT

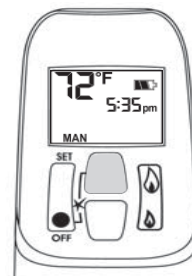



- In standby mode: Press and hold 🔥 (large flame) button to increase flame height.

MAXITROL GV60 CONTROL SYSTEM

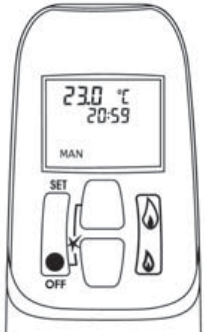
MAN



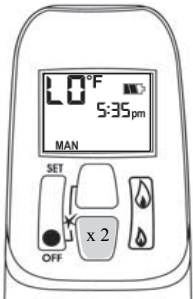

- Press and hold  (small flame) button to decrease flame height or to set the appliance at pilot flame.
- For fine adjustment tap the  (large flame) or  (small flame) buttons.

Express Low and High Fire



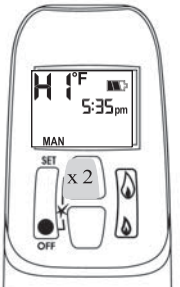

- Double-click  (small flame) button. “LO” will be displayed. NOTE: Flame goes to high fire first before going to designated low fire.



- Double-click  (large flame) button. Flame automatically goes to high fire. “HI” will be displayed.

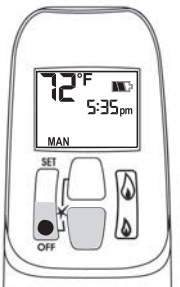

SETTING °C/24-HOUR OR °F/12-HOUR

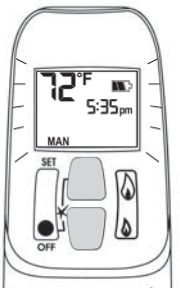

- In MAN mode, press OFF
- and  (small flame) buttons until display changes from Fahrenheit/12-hour clock to Celsius/24-hour clock and vice versa.

SETTING THE TIME



- The time display will flash after either:
 - » Installing the battery or
 - » Simultaneously pressing the  (large flame) and  (small flame) buttons
- Press  (large flame) button to set the hour.

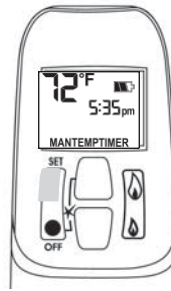

- Press  (small flame) button to set the minute.
- Press OFF or simply wait to return to MAN mode.

MODES OF OPERATION

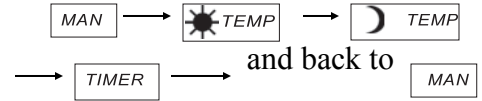

- Briefly pressing the SET button changes the mode of operation in the following order:



NOTE: Manual mode can also be reached by pressing either the  (large flame) or the  (small flame) buttons.

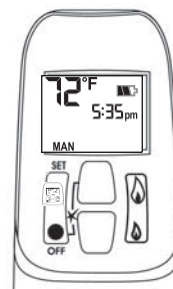

- **MAN** - **Manual Mode** - Manual Flame Height Adjustment.

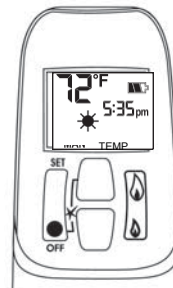

- **TEMP** - **Daytime Temperature Mode** (Appliance must be in standby mode; pilot ignited) - The room temperature is measured and compared to the set temperature. The flame height is then automatically adjusted to achieve the Daytime Set Temperature.

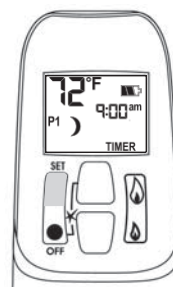

- **TEMP** - **Daytime Temperature Mode** (Appliance must be in standby mode; pilot ignited) - The room temperature is measured and compared to the set temperature. The flame height is then automatically adjusted to achieve the Daytime Set Temperature.

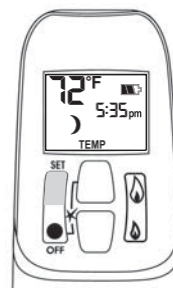

- **TIMER** - **Timer Mode** (Appliance must be in standby mode; pilot ignited) - The timers P1 and P2 (Program 1, Program 2) each can be programmed to go ON and OFF at specific times. For instructions see Timer Programming Mode.

NOTE: The display shows the set temperature every 30 seconds.

MAXITROL GV60 CONTROL SYSTEM

SETTING THE ON / OFF TEMPERATURES

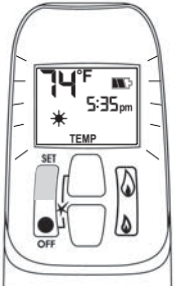

SETTING THE “DAYTIME” TEMPERATURE

Default Settings:  TEMP (sun), 23°C / 74°F



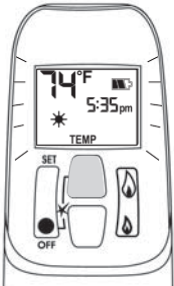

- Briefly press SET button to scroll to TEMP  TEMP (sun) mode. Hold the SET button until the TEMP flashes.

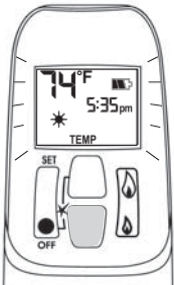

- Press  (large flame) button to increase the  daytime Set Temperature.



- Press  (small flame) button to decrease  Daytime Set Temperature.

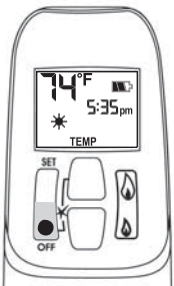

- Press OFF or simply wait to complete programming.

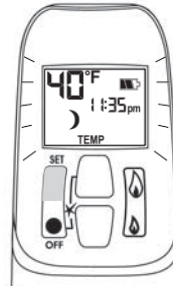

SETTING THE “NIGHTTIME SETBACK” TEMPERATURE

Default Settings:  TEMP (moon), “- -” (OFF)



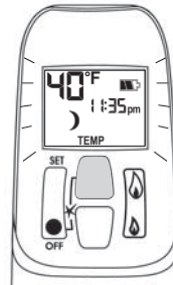

- Briefly press SET button to scroll to TEMP  TEMP (moon) mode. Hold the SET button until the TEMP flashes.

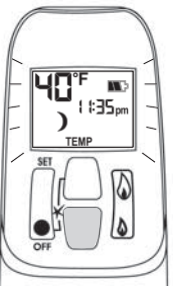

- Press  (large flame) button to increase  Nighttime Setback Temperature.



- Press  (small flame) button to decrease  Nighttime Setback Temperature.

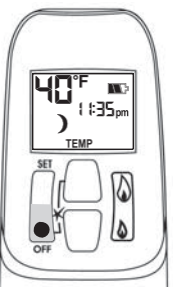

- Press OFF or simply wait to complete programming.

Tip

Set the different parameters when they are flashing.

MAXITROL GV60 CONTROL SYSTEM

SETTING PROGRAM TIMERS

- You can program two periods of time between 12:00 am and 11:50 pm in each 24-hour cycle.
- The Programs P1 and P2 must be set in the following order during a 24-hour cycle: **P1** ☽, **P1** ☾, **P2** ☀ and **P2** ☾.
- The icon ☀ indicates the beginning of the period (ON) and the icon ☾ indicates the end of the period (OFF).
- If **P1** ☀ = **P1** ☾, **P2** ☀ = **P2** ☾ the programming is cancelled.
- To keep the fireplace ON all night, set **P2** ☾ at 11:50 am and **P1** ☀ at 12:00 am.

Default settings:

Program 1: **P1** ☀ 6:00 am **P1** ☾ 8:00 am
 Program 2: **P2** ☀ 11:50 pm **P2** ☾ 11:50 pm

- Briefly press SET button to scroll to TIMER mode.

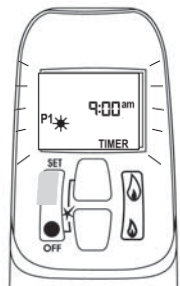
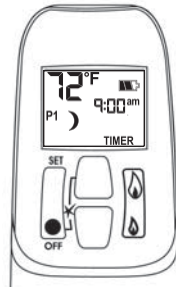

SETTING P1 ON TIME

- Hold the SET button until **P1** ☀ (sun) is displayed and the time flashes.

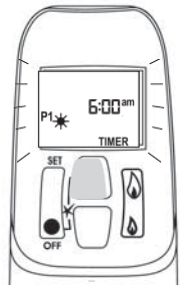

- Press ☹ (large flame) button to set the hour.

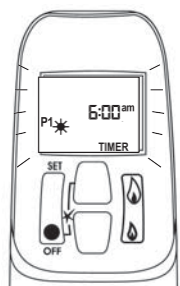

- Press ☺ (small flame) button to set the minutes.

SETTING P1 OFF TIME

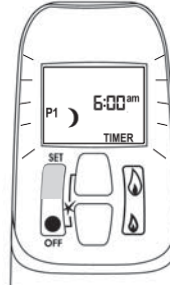

- Briefly press SET button or scroll to **TIMER P1** ☾ (moon) while the time flashes.



- Press ☹ (large flame) button to set the hour.



- Press ☺ (small flame) button to set the minutes.

SETTING P2 ON TIME

- Briefly press SET to scroll to **TIMER mode P2** ☀ (sun) while the time flashes.
- Follow the instructions given to set P1 ON time.

SETTING P2 OFF TIME

- Briefly press SET to scroll to **TIMER mode P2** ☾ (moon) while the time flashes.
- Follow the instructions given to set P1 OFF time.

Press OFF button to save these settings. The timers are programmed. See the diagram on programming sequences on the following page.

Tip

If you want to program only one period, program **P1** ☀ and **P1** ☾ with desired times and program **P2** ☾ and **P2** ☾ with the same time as **P1** ☾.

MAXITROL GV60 CONTROL SYSTEM

Timer Programming Example (default temperatures shown)

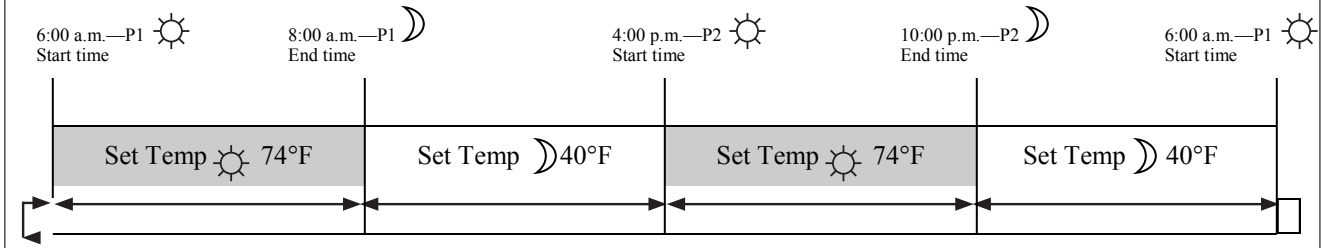

AUTOMATIC TURN DOWN

- **No communication.** If there is no communication between the receiver and the handset for a period of 6 hours, the appliance goes into pilot mode.
- **No change in flame height.** If there is no change in flame height for a period of 6 hours, the appliance goes into pilot mode.

NOTE: In **TEMP** or **TIMER** modes, the flame height will vary according to room temperature. The appliance will continue to work normally. However, if the room temperature remains the same for 6 hours, the appliance will go into pilot mode.

AUTOMATIC SHUT OFF

- **Low batteries in the receiver.** With low battery power in the receiver the system shuts off completely.

NOTE: This does not apply when the power supply is interrupted.

No change in pilot. The appliance shuts off completely when it is continually in pilot position—without any change—for a period of 5 days.

LOW BATTERY INDICATION

CAUTION

DO NOT USE a screwdriver or other metallic object to remove the batteries from the battery box or the handset! This could cause a short circuit.

Remote handset: The battery icon  will show when the battery needs to be replaced. Replace with one 3 “AAA” **alkaline** batteries.

Receiver: Three short ‘beeps’ will sound when the motor turns when the batteries need to be replaced. Replace with four 1.5 V **alkaline** batteries.

HANDSET / RECEIVER MATCH

The remote control handset and receiver are programmed to function together. In case of a replacement of the handset or the receiver, you will need to reset the receiver to allow them to function together. Contact your dealer for details.

GAS CONVERSION

This appliance is equipped from the factory for use with Natural gas, if use with propane is desired, the unit is field convertible to Propane when a SÓLAS gas conversion kit is used. Gas conversions must be performed by a qualified service technician.

PART #	DESCRIPTION	SÓLAS CONVERSION KIT CONTENTS		
SL26FI-LPC	TWENTY6 FI LP CONVERSION KIT	#27 PILOT ORIFICE	#55 LP BURNER ORIFICE - 1PC	#8 SCREW - 1PC

Before servicing the appliance, shut off gas and electrical power to the unit. To access the burner, follow the screen and glass removal procedure shown on pages 31 and 32.

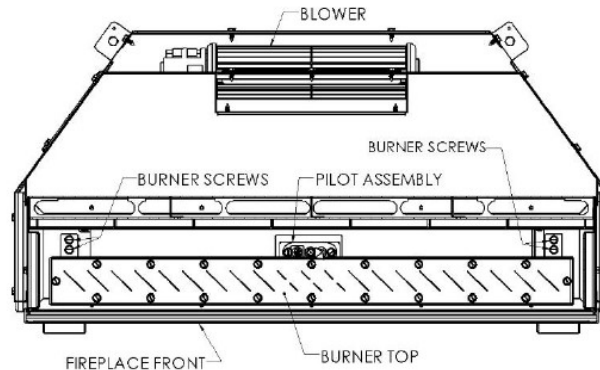

1. The burner is retained by (4) #10 sheet metal screws, using a 5/16" nut driver, remove these screws. The image above shows the location of these screws looking down at the top of the burner top inside the firebox. Slide the burner to the right and lift up to remove. (Fig. 1)
2. The Pilot assembly is retained by (2) #10 sheet metal screws.
3. After removing the screws retaining the pilot assembly, lift the pilot assembly into the firebox.
4. Using a 10mm wrench, remove the pilot gas line to swap the orifice. (Fig. 3)
5. Once the pilot gas line is tight, reinstall the pilot assembly making sure the gasket is intact.



(Fig. 1)

Engage the pilot gas line with the pilot orifice as shown:



(Fig. 2)

(Fig. 3)



(Fig. 4)



(Fig. 5)

CAUTION: USE CARE NOT TO CRACK THE CERAMIC IGNITOR!

GAS CONVERSION

6. When converting from Natural Gas to Propane, remove the NG Collar from the burner inlet tube. Reinstall #8 screw in burner tube. A replacement screw has been provided in the conversion kit in the event that a new screw is required.
7. Using a 9/16" deep socket, replace the burner orifice in the firebox with the orifice provided in the conversion kit.
8. Reinstall the burner in the fireplace.
9. Using a flat screw driver, remove the Pressure Conversion Plug and set it to LP as shown. (Fig. 10)



Natural Gas (Fig. 7)



Liquid Propane Gas (Fig. 8)

Gas Flow Adjustment

1. Install a gas pressure gage on the outlet pressure tap on the valve.
2. Light the fireplace using the remote handset.
3. Using a Monometer and with the fireplace on high, set the maximum pressure by adjusting the small flat screw set within the Pressure Conversion Plug with a Jeweler's screwdriver. Refer to chart below for high pressure settings. (Fig. 6)
4. double tap the down arrow on the remote to set the fireplace to low. "Lo" will momentarily appear on the display.
5. The minimum rate can be set by adjusting the minimum rate screw using a 4mm allen key. Refer to the chart below for Low pressure settings. (Fig. 9)
6. Close the pressure tap(s) by turning the screws clockwise. Check all connections/pressure taps for leaks. (Fig. 9)

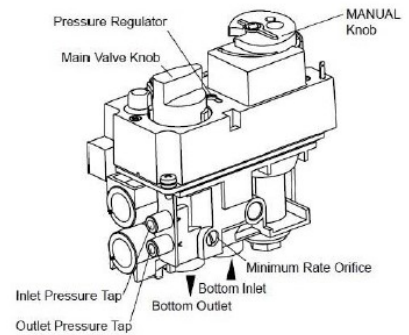

(Fig. 9)



(Fig. 10)



(Fig. 6)

MODEL	HIGH PRESSURE (LPG)	LOW PRESSURE (LPG)
TWENTY6 FI	10.0" w.c. / 2.5kPa	6.0" w.c. / 1.5kPa

CAUTION: CHECK ALL GAS CONNECTIONS FOR LEAKS INCLUDING AT PILOT AND VALVE

MAINTENANCE

A qualified service agency should conduct an annual inspection and maintenance of your **TWENTY6 FI** Fireplace Insert including the overall installation and venting to keep it running safely. The following procedures should be performed only by a qualified service person. The gas supply should be turned off and the stove should be completely cool whenever a maintenance procedure is performed. All parts of the appliance that are removed for servicing must be replaced prior to operation.

WARNING: Do not operate the appliance with the glass front removed, cracked or broken. Replacement of the glass should be done by a qualified service person.

WARNING: Use only glass assembly, P/N 36-510 which includes the glass panel, frame and gasket. Do not use substitute materials. Do not strike or slam the glass front. The appliance area must be kept clear and free from combustible materials, gasoline and other flammable vapors and liquids.

CAUTION: DO NOT OPERATE WITH BROKEN GLASS

REPLACING THE GLASS

The glass mounting system consists of the glass panel, special glass gasket and the metal glass frame. Should the glass need to be replaced, you must replace the entire glass/glass frame assembly (PN 36-510). See page 30 for information on obtaining replacement parts. Use the following procedure and refer to the illustrations on page 16 of this manual.

1. Turn the fireplace completely off and allow it to cool to room temperature.
2. Remove the fireplace surround. See instructions on page 18.
3. If the glass is broken, be sure to wear gloves and eye protection.
4. Remove the glass frame retaining clips from the top edge of the glass frame.
5. This will allow the glass frame to tip slightly forward. The glass may be loose in the frame, so it is very important to support both the glass and the frame when handling. Place your thumbs on the outside of the glass frame and wrap your fingers around the frame and onto the glass. Squeeze the frame and glass while moving. Carefully lift the glass frame and glass up and off the fireplace. Set the glass and frame aside on a padded surface. If the glass is broken, do this over spread out newspaper to catch all loose material. Wrap the old glass frame, glass and gasket in several layers of newspaper and discard.

Installing the replacement glass/glass frame assembly.

1. Unpack the new glass/glass frame assembly taking care when handling.
2. Carefully pick up the glass and glass frame assembly by grasping the sides of the frame and using your thumbs and fingers to hold the glass in place within the gasket and frame.
3. With the glass frame (and glass) at a slight angle (leaving room for your fingers between the frame and the firebox) insert the bottom edge of the frame into the frame retainer located on the bottom front of the firebox. Take care to center the frame from left to right. Once the bottom edge is in place, move your fingers out of the way and press the top of the frame against the firebox while pushing down to be sure the frame is fully engaged in the frame retainer. Hold the frame in place with one hand and reinstall the glass frame fasteners, leaving them loose.
4. Tighten the glass frame fasteners in stages working from the center out. Continue the process until all fasteners are uniformly tight. Do not over-tighten the fasteners.
5. Replace the fireplace surround. See instructions on page 18.

CLEANING THE GLASS & INNER PORCELAIN ENAMEL PANELS

WARNING: Never clean the glass or panels while they are hot. Do not use abrasive cleaners or cleaners containing ammonia.

NOTE: A micro-fiber cleaning cloth and plain water is recommended by the glass manufacturer.

MAINTENANCE

Inspecting the Venting

An inspection of both the air intake, exhaust vent pipe and the vent terminal should be made as part of the annual service appointment. The venting must have no blockage and be in good repair. The vent manufacturer's instructions may provide specific details on vent inspection. Any vent sections that are disassembled must be reassembled and sealed as required. Any safety screen, guard, or barrier removed for servicing an appliance must be replaced prior to operating the appliance.

This appliance should be inspected before use and at least annually by a qualified service person. More frequent cleaning may be required due to excessive dust or lint from carpeting, bedding materials, pets, etc. It is imperative that control compartments and circulating air passageways of this appliance be kept clean.

Cleaning the Burner and Firebox

During the annual inspection and maintenance appointment, the service person should clean the burner and firebox. To gain access to the firebox and burner, follow the instructions beginning on page 16 of this manual.

DO NOT USE A VACUUM CLEANER TO CLEAN THE GLASS BURNER MEDIA.

A vacuum cleaner may be used to clean the metal parts of the firebox. Leave the glass burner media in place. Use a soft brush to clean the burner glass media. If the burner media does need to be removed, carefully scoop it off the burner and avoid dropping glass pieces in the air gaps around the burner. Follow the instructions on page 17 of this manual when replacing the burner media on the burner top.

Air Flow

The **TWENTY6 FI** Fireplace Insert utilizes a convection air blower to maximize heat delivered from the fireplace. It is important that air flows freely through the convection air system and out the top of the raised section of the surround. Do not place objects under the fireplace that will block the convection air inlet flow or in front of the air outlet.

MAINTENANCE LOG

We strongly recommend that you keep a log of the regular maintenance that is performed on your fireplace. We have provided the forms below to make it easy. Simply ask your qualified service person to fill out one of the maintenance record forms below, each time the fireplace is serviced. This will help insure that all of the required maintenance procedures have been completed, at least annually. Regular maintenance will help keep the fireplace functioning in a safe and reliable manner. Additional forms are available from your installer or service person when needed.

Date of Service _____
Serviced By _____
Service Performed
 Inspect Venting
 Clean Burner & Firebox
 Clean Control Area
 Clean Convection Air System
 Leak Test Gas Connections
 Other _____

Date of Service _____
Serviced By _____
Service Performed
 Inspect Venting
 Clean Burner & Firebox
 Clean Control Area
 Clean Convection Air System
 Leak Test Gas Connections
 Other _____

Date of Service _____
Serviced By _____
Service Performed
 Inspect Venting
 Clean Burner & Firebox
 Clean Control Area
 Clean Convection Air System
 Leak Test Gas Connections
 Other _____

Date of Service _____
Serviced By _____
Service Performed
 Inspect Venting
 Clean Burner & Firebox
 Clean Control Area
 Clean Convection Air System
 Leak Test Gas Connections
 Other _____

Date of Service _____
Serviced By _____
Service Performed
 Inspect Venting
 Clean Burner & Firebox
 Clean Control Area
 Clean Convection Air System
 Leak Test Gas Connections
 Other _____

Date of Service _____
Serviced By _____
Service Performed
 Inspect Venting
 Clean Burner & Firebox
 Clean Control Area
 Clean Convection Air System
 Leak Test Gas Connections
 Other _____

REPLACEMENT PARTS LIST

PART NAME	P/N	PART NAME	P/N
Pilot Head NG/LP	26-501	Burner Orifice (NG)	36N-509
Pilot Thermocouple*	M26-502*	Burner Orifice (LP)	36P-509
Pilot Injector (NG)	26N-503	Burner Glass Media – Clear	26-511
Pilot Injector (LP)	26P-503	Burner Module (NG)	36N-901
Receiver Module (Maxitrol)	M46-504	Burner Module (LP)	36P-901
Remote Handset (Maxitrol)	M46-507	Firebox Panel – Rear	36-512
Gas Valve (Maxitrol)	M46-515	Firebox Panel – Left	36-513
TC Line Red	M46-701	Firebox Panel – Right	36-514
TC Line Yellow	M46-702	Thermocouple Interrupter Block	M46-703
8-Wire Connecting Cable	M46-704	Replacement Blower	36-531
Flue Restrictor (E & F)	36-533	Module for Additional Function	36-560
Power Cord Assembly	36-536	Blower Wire Harness	36-561
Convection Duct	36-537	Connecting Cable, Receiver	36-562
Glass Assembly (Including Glass frame, Glass, and Gasket. Replace only as assembly)			36-510

***This is a quick response thermocouple. Replace it only with SÓLAS Part Number M26-502.**

For replacement parts and customer service, contact your **TWENTY6 FI** dealer or:

SÓLAS, LLC
 4 Technology Drive, Suite 5
 West Lebanon, NH 03784
 (T) 603-298-5778
 (F) 603-298-9246
sales@solasfires.com

CONTROL SCHEMATIC

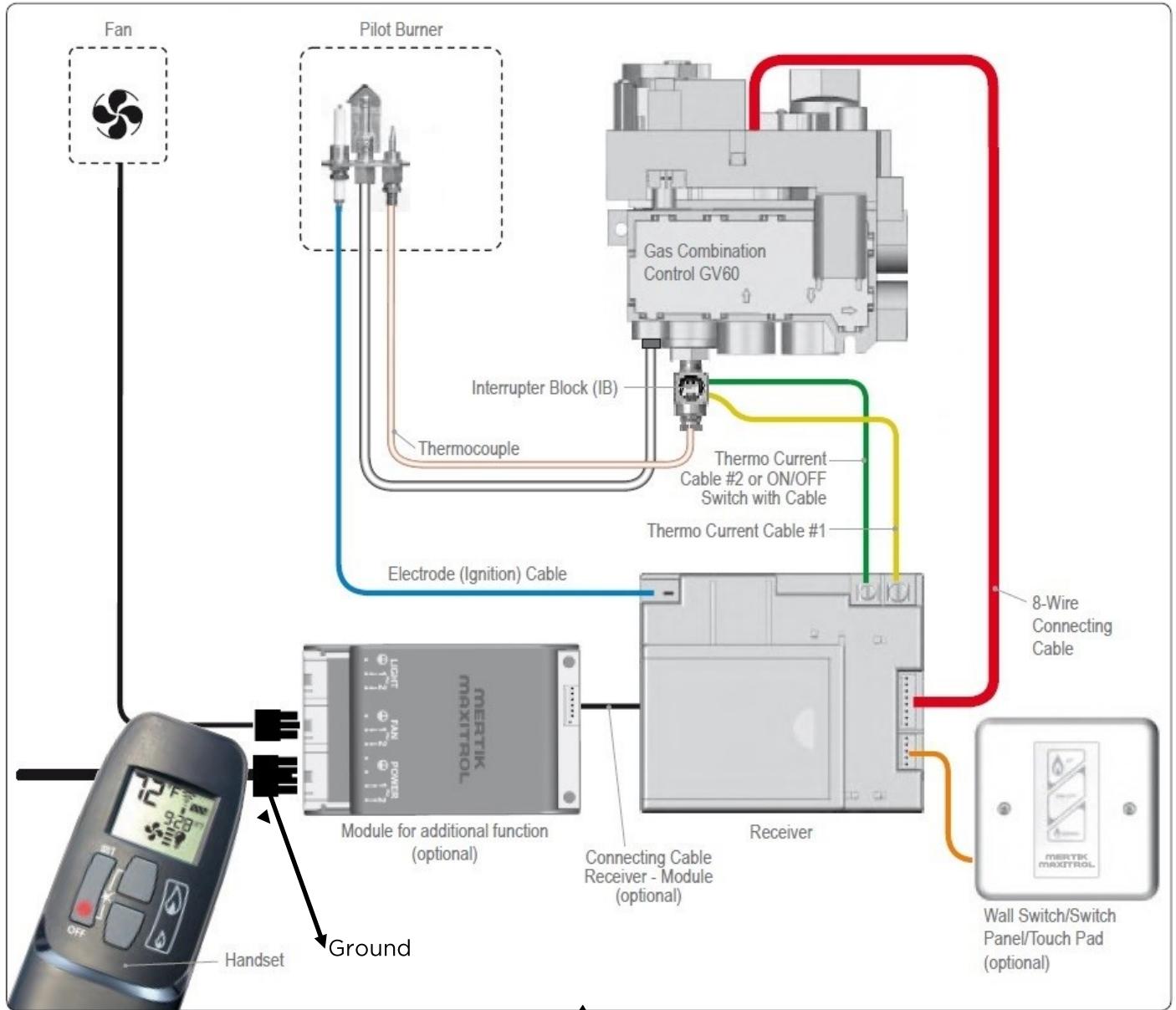

Caution: Label all wires prior to disconnection when servicing the controls. Wiring errors can cause improper and dangerous operation. Verify proper operation after servicing.

INSTALLATION RECORD

The installer should complete the form below that describes the details of the installation. Having this written record of installation information available will greatly expedite trouble-shooting should any problem arise with your stove. The installer should keep a duplicate of this form for their records.

DATE PURCHASED:	<input style="width: 100%;" type="text"/>		
DEALER:	<input style="width: 100%;" type="text"/>		
INSTALLER:	<input style="width: 100%;" type="text"/>		
FIREPLACE S/N:	<input style="width: 100%;" type="text"/>		
DATE INSTALLED:	<input style="width: 100%;" type="text"/>		
FUEL:	<input type="checkbox"/> NAT. GAS	<input type="checkbox"/> LP GAS	
INLET PRESSURE MEASURED AFTER INSTALLATION:	<input style="width: 50px;" type="text"/>	IN. WC	
MANIFOLD PRESSURE MEASURED AFTER INSTALLATION:			
	HIGH FIRE:	<input style="width: 50px;" type="text"/>	IN. WC
	LOW FIRE:	<input style="width: 50px;" type="text"/>	IN. WC
VENTING:			
VENT BRAND:			
Simpson DuraVent <input type="checkbox"/>			
VENT TERMINATION (CAP):			
VENT CAP MODEL NO: _____			
<u>CONFIGURATION</u>			
TOTAL HORIZONTAL RUN:	<input style="width: 80px;" type="text"/>	FEET/INCHES	
TOTAL VERTICAL RISE:	<input style="width: 80px;" type="text"/>	FEET/INCHES	
ALTITUDE: <input style="width: 100px;" type="text"/> FEET ABOVE SEA LEVEL			
WAS STOVE DERATED? <input style="width: 100px;" type="text"/> Y or N? IF YES, TO WHAT ORIFICE SIZE? <input style="width: 50px;" type="text"/>			
UNUSUAL STRUCTURE NEAR VENT TERMINATION - DESCRIBE:	INSIDE CORNER	TREES/SHRUBS	OTHER
PREVALENT WIND CONDITIONS?			
OTHER INSTALLATION NOTES:			



4 Technology Drive, Suite 5
 West Lebanon, NH 03784
 (T) 603-298-5169
 (F) 603-298-9246
 sales@solasfires.com

WARRANTY-

TY INFORMATION

THE WARRANTY

SOLAS, LLC, a division of Progressive Manufacturing, Inc. (“SOLAS”), Limited Lifetime Warranty warrants your SOLAS brand gas fireplace (“Product”) to be free from defects in materials and workmanship at the time of manufacture. The Product body and firebox carry the Limited Lifetime Warranty on workmanship defects causing loss of structural integrity. Ceramic glass carries the Limited Lifetime Warranty against thermal breakage only. After installation, if covered components manufactured by SOLAS are found to be defective in material or workmanship during the Limited Lifetime Warranty period and while the Product remains at the site of the original installation, SOLAS will, at its option, repair or replace the covered components. If repair or replacement is not commercially practical, SOLAS will, at its option, refund the purchase price or wholesale price of the SOLAS product, whichever is applicable. SOLAS will also pay their prevailing labor rates, as determined in its sole discretion, incurred in repairing or replacing such components during the warranty period. THERE ARE EXCLUSIONS AND LIMITATIONS to this Limited Lifetime Warranty as described herein.

COVERAGE COMMENCEMENT DATE

Warranty coverage begins on the date of installation. The warranty shall commence no later than 24 months following the date of product shipment from SOLAS, regardless of the installation date.

EXCLUSIONS AND LIMITATIONS

This Limited Lifetime Warranty applies only if the Product is installed in the United States or Canada and only if operated and maintained in accordance with the printed instructions accompanying the Product and in compliance with all applicable installation and building codes and good trade practices.

This warranty is non-transferable and extends to the original owner only. The Product must be purchased through a listed supplier of SOLAS and proof of purchase must be provided. The Product body and firebox carry the Limited Lifetime Warranty. The following do not carry the Limited Lifetime Warranty, but are warranted as follows:

- Burner** – Repair or replacement for three years from date of installation.
- Gas components & electrical components** – Repair or replacement for one year from date of installation.
- Blowers & remote controls** – Repair or replacement for one year from the date of installation.
- Porcelain Firebox Liners** – Replacement for one year against cracking or breakage due to thermal stress from date of installation. Excludes surface and hairline cracks and scratches or slight color changes that do not affect the operation or safety of the unit.
- Gaskets** – Repair or replacement for one year from the date of installation.
- Surrounds** – Replacement for one year against cracking or breakage due to thermal stress. Excludes surface and hairline cracks and scratches or slight color changes that do not affect the operation or safety of the unit.
- Labor coverage** – Prevailing SOLAS rates apply for the warranty period of the component. SOLAS will not be liable for travel costs for service work.

SOLAS will not be responsible for: (a) damages caused by normal wear and tear, accident, riot, fire, flood, or acts of God; (b) damages caused by abuse, negligence, misuse, or unauthorized alteration or repair of the Product affecting its stability or performance. The Product must be subjected to normal use. The product is designed to burn either natural or propane gas only. Burning conventional fuels such as wood, coal or any other solid fuel will cause damage to the Product, will produce excessive temperatures and could result in a fire hazard. (c) Damages caused by failing to provide proper maintenance and service in accordance with the instructions provided with the Product; (d) damages, repairs or inefficiency resulting from faulty installation or application of the Product.

Discoloration and some minor expansion, contraction, or movement of certain parts and resulting noise is normal and not a defect, and, therefore, not covered under warranty. The installer must ensure the appliance is burning as per the rating tag at the time of installation. Over-firing (operation above the listed BTU rate) of this appliance can cause serious damage and will nullify this warranty.

This warranty is void if:

- The unit has been operated in atmospheres contaminated by chlorine, fluorine or other damaging chemicals.
- The unit is subject to submersion in water or prolonged periods of dampness or condensation.
- Any damage to the unit, combustion chamber, heat exchanger or other components due to water or weather damage which is the result of, but not limited to improper chimney/venting installation.

Damage to stainless steel, gold, nickel or porcelain enameled surfaces caused by fingerprints, scratches, melted items, or other external sources left on these surfaces from the use of cleaners is not covered in this warranty.

SOLAS is not responsible for inadequate fireplace system draft caused by air conditioning and heating systems, mechanical ventilation systems, or general construction conditions which may generate negative pressure in the room in which the appliance is installed. Additionally, SOLAS assumes no responsibility for drafting conditions caused by venting configurations, adjoining trees or buildings, adverse wind conditions or unusual environmental factors and conditions that affect the operation of the unit.

This Limited Lifetime Warranty covers only parts and labor as provided herein. In no case shall SOLAS be responsible for materials, components, or construction, which are not manufactured or supplied by SOLAS or for the labor necessary to install, repair, or remove such materials, components, or construction. Additional utility bills incurred due to any malfunction or defect in equipment are not covered by this warranty. All replacement or repair components will be shipped F.O.B. from the nearest stocking SOLAS facility.

LIMITATION ON LIABILITY

It is expressly agreed and understood that SOLAS’ sole obligation and the purchaser’s exclusive remedy under this warranty, under any other warranty, expressed or implied, or in contract, tort or otherwise, shall be limited to replacement, repair, or refund, as specified herein.

In no event shall SOLAS be liable for any incidental or consequential damages caused by defects in the Product, whether such damage occurs or is discovered before or after repair or replacement, and whether such damage is caused by SOLAS’ negligence. SOLAS has not made and does not make any representation or warranty of fitness for a particular use or purpose, and there is no implied condition of fitness for a particular purpose.

SOLAS makes no expressed warranties except as stated in this Limited Lifetime Warranty. The duration of any implied warranty is limited to the duration of this expressed warranty.

No one is authorized to change this Limited Lifetime Warranty or to create for SOLAS any other obligation or liability in connection with the Product. Some states and provinces do not allow the exclusion or limitation of incidental or consequential damages, so the above limitations or exclusions may not apply to you. The provisions of this Limited Lifetime Warranty are in addition to and not a modification of or subtraction from any statutory warranties and other rights and remedies provided by law.

INVESTIGATION OF CLAIMS AGAINST WARRANTY

SOLAS reserves the right to investigate any and all claims against this Limited Lifetime Warranty and to decide, in its sole discretion, upon the method of settlement.

To receive the benefits and advantages described in this Limited Lifetime Warranty, the appliance must be installed and repaired by a licensed contractor approved by SOLAS.

Contact SOLAS at the address provided herein to obtain a listing of approved dealers/distributors. **SOLAS shall in no event be responsible for any warranty work done by a contractor that is not approved without first obtaining SOLAS’ prior written consent.**

HOW TO REGISTER A CLAIM AGAINST WARRANTY

In order for any claim under this warranty to be valid, you must contact the SOLAS dealer/distributor from which you purchased the product. If you cannot locate the dealer/distributor, then you must notify SOLAS in writing. SOLAS must be notified of the claimed defect in writing within 90 days of the date of failure. Notices should be directed to the SOLAS Warranty Department at 4 Technology Drive, Suite 5, West Lebanon, NH 03784 or visit our website at www. SOLAS fires.com.

 <p>NATIONAL FIREPLACE INSTITUTE NFI CERTIFIED www.nficertified.org</p>	<p>We recommend that our gas hearth products be installed and serviced by professionals who are certified in the U.S. by the National Fireplace Institute® (NFI) as NFI Gas Specialists.</p>
---	--

RECORD YOUR PRODUCT INFORMATION

Model #: _____	Serial #: _____
Date Purchased: _____	Date Installed: _____



Manufactured by:
 Progressive Manufacturing Inc.
 4 Technology Drive, Suite 5
 West Lebanon, NH 03784
 USA