

SÓLAS

CONTEMPORARY FIRE

TWENTY6

INSTALLATION & OPERATION MANUAL

WALL MOUNT DIRECT VENT GAS FIREPLACE

This manual specifies the installation and operation requirements for the **SÓLAS TWENTY6** Fireplace. Model Nos. SL-26N WITH SCREEN, SL-26P WITH SCREEN.



WARNING:

FIRE OR EXPLOSION HAZARD

Failure to follow safety warnings exactly could result in serious injury, death, or property damage

— Do not store or use gasoline or other flammable vapors and liquids in the vicinity of this or any other appliance.

— **WHAT TO DO IF YOU SMELL GAS**

- Do not try to light any appliance.
- Do not touch any electrical switch; do not use any phone in your building.
- Leave the building immediately
- Immediately call your gas supplier from a neighbor's phone. Follow the gas supplier's instructions.
- If you cannot reach your gas supplier, call the fire department.

— Installation and service must be performed by a qualified installer, service agency or the gas supplier.

This appliance may be installed in an aftermarket, permanently located manufactured home (USA only) or in a mobile home, where not prohibited by local codes.

This appliance is for use only with the type of gas indicated on the rating plate. This appliance is not convertible for use with other gases, unless a certified conversion kit is used.

DANGER

HOT GLASS WILL CAUSE BURNS.

DO NOT TOUCH GLASS UNTIL COOLED.

NEVER ALLOW CHILDREN TO TOUCH GLASS.

A barrier designed to reduce the risk of burns from the hot viewing glass is provided with this appliance and shall be installed for the protection of children and other at-risk individuals.

Ce manuel est disponible en Français sur demande.



OMNI-Test Laboratories, Inc.

Report #0361GF001S

INSTALLER: Leave this manual with the appliance | **CONSUMER:** Retain this manual for future reference

AVERTISSEMENT: Assurez-vous de bien suivre les instructions données dans cette notice pour réduire au minimum le risque d'incendie ou d'explosion ou pour éviter tout dommage matériel, toute blessure ou la mort.

- Ne pas entreposer ni utiliser d'essence ni d'autres vapeurs ou liquides inflammables dans le voisinage de cet appareil ou de tout autre appareil.

- QUE FAIRE SI VOUS SENTEZ UNE ODEUR DE GAZ:

- **Ne pas tenter d'allumer d'appareil.**
- **Ne touchez à aucun interrupteur. Ne pas vous servir des téléphones se trouvant dans le bâtiment où vous trouvez.**
- **Appelez immédiatement votre fournisseur de gaz depuis un voisin. Suivez les instructions du fournisseur.**
- **Si vous ne pouvez rejoindre le fournisseur de gaz, appelez le service des incendies.**

- L'installation et l'entretien doivent être assurés par un installateur ou un service d'entretien qualifié ou par le fournisseur de gaz.

Cet appareil peut être installé dans une maison préfabriquée (mobile) déjà installée à demeure si les règlements locaux le permettent.

Cet appareil doit être uniquement avec le type de gaz indiqué sur la plaque signalétique. Cet appareil ne peut être converti à d'autres gaz, sauf si une trousse de conversion est utilisée.

Ne pas utiliser cet appareil s'il a été plongé, même partiellement, dans l'eau. Appeler un technicien qualifié pour inspecter l'appareil et remplacer toute partie du système de commande et toute commande qui a été plongée dans l'eau.

Attention. Au moment de l'entretien des commandes, étiquetez tous les fils avant de les débrancher. Des erreurs de câblage peuvent entraîner un fonctionnement inadéquat et dangereux.

S'assurer que l'appareil fonctionne adéquatement une fois l'entretien terminé.

AVERTISSEMENT. Ne pas utiliser l'appareil si le panneau frontal en verre n'est pas en place, est craqué ou brisé. Confiez le remplacement du panneau à un technicien agréé.

**INSTALLATEUR: Laissez cette notice avec l'appareil.
COMSOMMATEUR: Conservez cette notice pour consultation ultérieure.**

TABLE OF CONTENTS

IMPORTANT SAFETY INFORMATION	4
SPECIFICATIONS	5
INSTALLATION REQUIREMENTS	6
MASSACHUSETTS REQUIREMENTS	7
VENTING	8
ASSEMBLY & INSTALLATION	16
GAS CONNECTION	20 & 26
LIGHTING AND OPERATION	32
MAXITROL CONTROL SYSTEM	34
MAINTENANCE	41
MAINTENANCE LOG FORMS	43
REPLACEMENT PARTS LIST	44
CONTROL SCHEMATIC	45
INSTALLATION RECORD FORM	46
WARRANTY INFORMATION	47

WE STRONGLY SUGGEST THAT YOU READ THIS MANUAL THOROUGHLY BEFORE BEGINNING THE INSTALLATION OF THE TWENTY6 DIRECT VENT GAS FIREPLACE. ALTHOUGH THE BASIC REQUIREMENTS FOR THE INSTALLATION OF ALL DIRECT VENT GAS FIREPLACES ARE SIMILAR, EACH SPECIFIC PRODUCT HAS ITS OWN UNIQUE SET-UP AND INSTALLATION REQUIREMENTS THAT MUST BE FOLLOWED EXACTLY. PLAN YOUR INSTALLATION IN ADVANCE BY CAREFULLY REVIEWING ALL THE INFORMATION CONTAINED IN THIS MANUAL.

IMPORTANT SAFETY INFORMATION

The installation must conform with local codes or, in the absence of local codes, with the *National Fuel Gas Code, ANSI Z223.1/NFPA 54*, or the *Natural Gas and Propane Installation Code, CSA B149.1*.

A manufactured home (USA only) or mobile home OEM installation must conform with the *Manufactured Home Construction and Safety Standard, Title 24 CFR, Part 3280* or when such a standard is not applicable, the *Standard for Manufactured Home Installations, ANSI/BCSBCS A225.1*, or *Standard for Gas Equipped Recreational Vehicles and Mobile Housing, CSA Z240.4*.

The appliance and its appliance main gas valve must be disconnected from the gas supply piping system during any pressure testing of that system at test pressures in excess of 1/2 psi (3.5 kPa).

The appliance must be isolated from the gas supply piping system by closing its equipment shutoff valve during any pressure testing of the gas supply piping system at test pressures equal to or less than 1/2 psi (3.5 kPa).

The installation must provide for adequate ventilation air to the appliance.

This gas appliance must not be connected to a chimney flue serving a separate solid-fuel burning appliance.

The appliance, when installed, must be electrically grounded in accordance with local codes, or, in the absence of local codes, with the *National Electrical Code ANSI/NFPA 70*, or the *Canadian Electrical Code, CSA C22.1*.

The appliance area must be kept clear and free from combustible materials, gasoline and other flammable vapors and liquids.

The flow of combustion and ventilation air must not be obstructed.

Do not use this appliance if any part has been under water. Immediately call a qualified service technician to inspect the appliance and to replace any part of the control system and any gas control which has been under water.

Due to high temperatures, the appliance should be located out of traffic and away from furniture and draperies.

Children and adults should be alerted to the hazards of high surface temperatures and should stay away to avoid burns or clothing ignition.

Young children should be carefully supervised when they are in the same room as the appliance. Toddlers, young children and others may be susceptible to accidental contact burns. A physical barrier is recommended if there are at-risk individuals in the house. To restrict access to a fireplace or a stove, install an adjustable safety gate to keep toddlers, young children and other at-risk individuals out of the room and away from hot surfaces.

A barrier designed to reduce the risk of burns from the hot viewing glass is provided with this appliance and shall be installed for the protection of children and other at-risk individuals.

If the barrier becomes damaged, the barrier shall be replaced with the manufacturer's barrier for this appliance.

Clothing or other flammable material should not be placed on or near the appliance.

Any screen or guard removed for servicing an appliance must be replaced prior to operating the appliance.

Installation and repair should be done by a qualified service person. The appliance should be inspected before use and at least annually by a professional service person. More frequent cleaning may be required due to excessive lint from carpeting, bedding material, etc. It is imperative that the control compartments, burners and circulating air passageways of the appliance be kept clean.

WARNING: Do not operate the appliance with the glass door assembly removed, or if the glass is cracked or broken. Replacement of the glass should be done by a qualified service person.

SPECIFICATIONS

INPUT

	<u>Natural Gas</u>	<u>Propane (LP)</u>
Input Rating-Btu/hr	19,000	19,000
Min. Input-Btu/hr	11,000	11,000
Orifice-DMS	5/64"	#55

GAS SUPPLY

Manifold Pressure	4.8" w.c. / 1.2kPa	10.0" w.c. / 2.5kPa
Min. Supply Pressure	5.5" w.c. / 1.4kPa	11.0" w.c. / 2.8kPa
Max. Supply Pressure	10.0" w.c. / 2.5kPa	13.0" w.c. / 3.3kPa

EFFICIENCY

Maximum Observed Steady State Efficiency - %	78.8	79.5
Steady State Efficiency - %	65.0	61.4
Annual Fuel Utilization Efficiency (AFUE) - %	64.2	60.5
Canadian p.4 Efficiency - %	55.1	50.0

NOTE: The maximum achievable steady state efficiency can vary depending on how the fireplace is installed and operated.

It is recommended that the pilot flame be turned off if the appliance will not be in use for an extended period of time.

This appliance is equipped for use with the fuel type indicated on the rating plate.

This appliance has been certified by OMNI-Test Laboratories, Inc. to ANSI Z21.88-2014/CSA 2.33-2014 Vented Gas Fireplace Heaters and CAN/CGA-2.17-M91, Gas-Fired Appliances for Use At High Altitudes.

The **TWENTY6** is approved for installation at elevations up to 2000 feet in the U.S. and 1370 meters (4500 feet) in Canada without change. If your installation is at an elevation greater than these, consult with the local authority having jurisdiction for gas product installations to determine their specific requirements for high altitude installations.

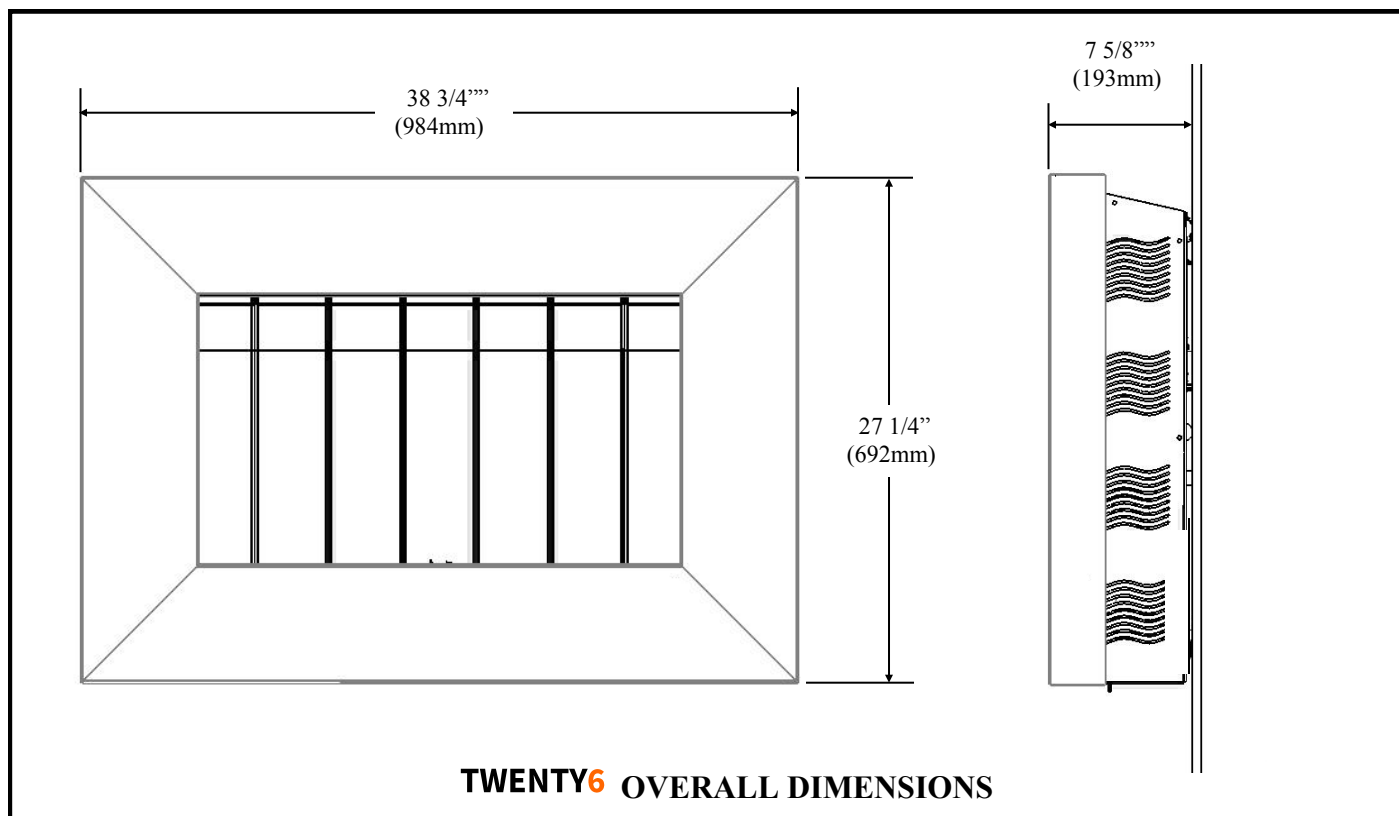

INSTALLATION REQUIREMENTS

Several issues must be addressed when selecting a suitable location for your **TWENTY6** fireplace. The minimum clearances to combustible construction are listed below. In addition, access to the gas supply must be considered. The location of the fireplace will also affect the venting requirements and you must be certain the location will allow compliance with the venting requirements shown on page 8. You must also insure that your installation provides adequate accessibility clearance for servicing and proper operation.

Installation and repair should be done by a qualified service person. The appliance should be inspected before use and at least annually by a professional service person. More frequent cleaning may be required due to excessive lint from carpeting, bedding material, etc. It is imperative that the control compartment, burners and circulating air passageways of the appliance be kept clean.

MINIMUM CLEARANCES TO COMBUSTIBLE CONSTRUCTION

Fireplace to L. Side Wall	6" (152mm)	Fireplace to Ceiling	8" (203mm)
Fireplace to R. Side Wall	6" (152mm)	Fireplace to Rear Wall	0" (0mm)*
Fireplace to Corner Wall	6" (152mm)	Fireplace to Floor	3" (76mm)**
Vent Pipe to Adjacent Materials	1.5" (38mm)		

*Mounting plate bosses contact the wall

**The minimum required clearance to be maintained from the fireplace to combustible flooring is measured from the top surface of carpeting, tile, etc.

A = 6" (152mm)

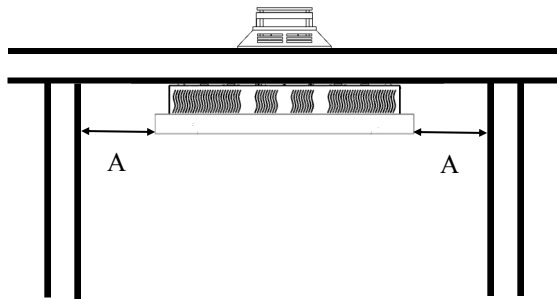

WALLS

CEILING

C = 8" (203mm)
D = 3" (76mm)

FLOOR

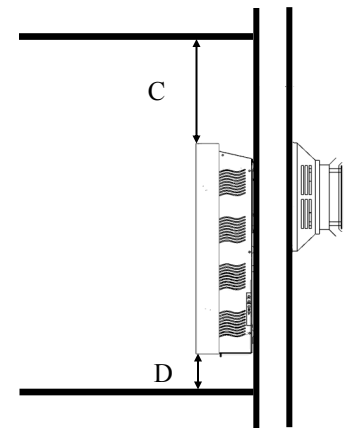

B = 6" (152mm)

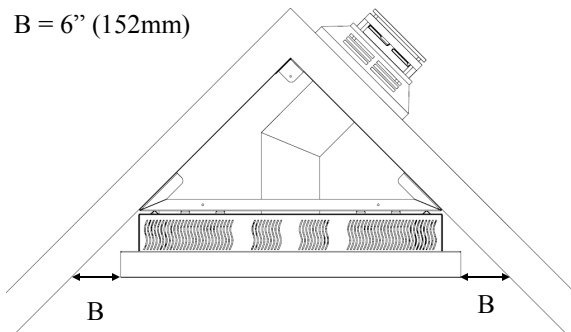

CORNER (SHOWN USING OPTIONAL CORNER KIT)

E = 5/16" (8mm)

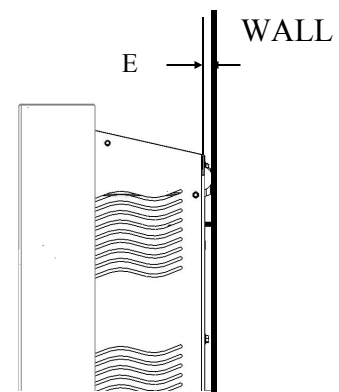

AIR SPACE BEHIND MOUNTING PLATE

INSTALLATION REQUIREMENTS

The gas fireplace is shipped with a 3/8" tube OD (male) connection. The gas supply piping should have a separate gas shutoff valve and a 1/8" NPT plugged tapping upstream of the valve. The stove and its main control valve must be disconnected from the gas supply piping system during any pressure testing of that system at test pressures in excess of 1/2 psi (3.5 kPa). The stove must be isolated from the gas supply piping system by closing the main control valve during any pressure testing of the gas supply system at test pressures equal to or less than 1/2 psi (3.5 kPa). After the gas supply has been connected, use a commercial gas leak detector or apply a soapy water solution to all the fittings to check for gas leaks. Never use a flame to test for leaks.

REQUIREMENTS FOR THE COMMONWEALTH OF MASSACHUSETTS

This product must be installed by a licensed plumber or gas fitter when installed within the Commonwealth of Massachusetts. If this appliance is installed in a dwelling, building or structure used in whole or in part for residential purposes and the installation includes a horizontal vent termination that is less than seven (7) feet above the finished grade in the area of the venting, including but not limited to decks and porches, a hard-wired carbon monoxide detector with an alarm and battery back-up must be installed on the floor level of the dwelling, building or structure where the appliance is to be installed.

Additionally, a hard-wired or battery operated carbon monoxide detector with an alarm must be installed on each additional level of the dwelling, building or structure served by the appliance. It shall be the responsibility of the property owner to secure the services of qualified licensed professionals for the installation of hard-wired carbon monoxide detectors.

In the event that the horizontally vented appliance is installed in a crawl space or attic, the hard-wired carbon monoxide detector with alarm and battery back-up may be installed on the next adjacent floor level.

In the event that this requirement cannot be met at the time of completion of the installation of the appliance, the owner shall have a period of thirty (30) days to comply with the requirement. However, during said thirty (30) day period, a battery operated carbon monoxide detector with alarm must be installed.

Each carbon monoxide detector as required in accordance with the above provisions must comply with NFPA 720 and be ANSI/UL 2034 and IAS certified.

In addition when the vent termination is less than seven (7) feet above finished grade a metal or plastic identification plate must be permanently mounted to the exterior of the building at a minimum height of eight (8) feet above grade directly in line with the exhaust vent terminal. The sign shall read, in print size no less than one-half (1/2) inch in size, "GAS VENT DIRECTLY BELOW. KEEP CLEAR OF ALL OBSTRUCTIONS".

A COPY OF THESE INSTRUCTIONS PLUS ALL VENTING INSTRUCTIONS WHICH INCLUDE PARTS LISTS, AND/OR ALL VENTING DESIGN INSTRUCTIONS MUST REMAIN WITH THE STOVE AT THE COMPLETION OF THE INSTALLATION.

- ATTENTION INSTALLERS:** Mark below which venting system was used in the installation. These instructions must remain with the **TWENTY6** Installation & Operation Manual.
- AmeriVent Direct™ Metal Fab Direct Vent ICC Direct Vent

VENTING

The **TWENTY6** Direct Vent Gas Fireplace has been tested and listed for installation with 4" X 6 5/8" Simpson DuraVent GS/Pro[®], Selkirk Direct-Temp[®], Security Secure Vent[™], AmeriVent Direct[™], Metal Fab Direct Vent and ICC EXCELDirect venting components. Although you may use the pipe components (straight pipe, elbows, etc.) from any of the listed manufacturers, you may only use the vent terminations (caps) listed in the chart on page 9. For installations where a snorkel is needed, please note that only three snorkels are approved for use. Please plan your installation accordingly.

For all specific venting installation requirements, follow the installation instructions included by the venting manufacturer with the venting system components you have chosen.

Please note:

- For venting configurations that include no vertical rise, a total horizontal vent run of up to 30 inches (and including one 45° elbow) is allowed. However, if your installation has room to add a vertical pipe section, we suggest adding at least one foot of vertical rise to the system.
- For venting configurations that include vertical rise, it is assumed that the installation will include at least one 90° elbow. Up to three additional 90° elbows (or equivalent 45° elbows) may also be used. The total venting may not exceed 20 feet of vertical rise and/or 10 feet horizontal run. Refer to the venting charts starting on pages 10 & 11 for specific details while you plan your installation. Note: The number of elbows impacts the maximum allowable horizontal vent run.
- Many installations will involve venting directly through standard 2 X 4 or 2 X 6 construction exterior wall to a horizontal vent termination (cap). The vent starter pipe has been designed to accommodate those two common installations without the use of any additional venting components other than a standard horizontal cap. See the chart on page 9 for a list of approved vent caps.
- A special corner installation kit (Part Number CK-26-1) is also available that will allow the **TWENTY6** fireplace to be mounted in a corner without constructing a 45° partition wall. This kit is available from your **TWENTY6** dealer and has its own installation instructions. Please refer to those instructions for specific details regarding the installation using the kit.
- If the fireplace will be installed on an interior wall or other location that precludes venting directly through an outside wall to a horizontal vent cap, or if the distance to the outside wall exceeds 30", one or more elbows will be required to allow addition of the required vertical venting to the installation. When vertical venting is required, the fireplace venting may be terminated with either a vertical or horizontal vent cap depending on the specifics of the installation. Refer to the venting charts starting on pages 10 & 11 for specific venting requirements and see the chart on page 9 for a list of approved vent caps before you plan your installation.
- There should be a 1 1/2" overlap of the vent and combustion air tubes, when telescopic joints are used.
- A minimum clear space of 1 1/2" must be maintained around the vent pipe where it penetrates the first combustible wall adjacent to the fireplace (either the outside wall for the direct-through-the-wall installation or the partition wall for the 45° or other interior wall installations). The special vent pipe heat shields that are provided with the **TWENTY6** must also be installed in the first wall adjacent to the fireplace. A minimum clear space of 1 1/2" must also be maintained where the vent pipe penetrates any other interior wall, exterior wall, ceiling or roof.
- The **TWENTY6** may also be installed in front of an existing fireplace opening utilizing special co-linear venting components available from the venting manufacturers. These systems split and then recombine the co-axial air and exhaust and allow the use of flexible venting. This makes it easier to run the venting through the narrow fireplace damper opening to the top of the chimney. Refer to the vent manufacturers' instructions. Use the vertical venting column (0 feet Horizontal Run) in the venting charts to determine the required restrictor settings depending on the height of chimney.

USING THE VENTING CHARTS

- The location of the vent termination must meet the requirements of the current edition of ANSI Z223.1/ NFPA 54, National Fuel Gas Code or CAN B419.1, Natural Gas and Propane Installation Code and the requirements shown on page 15 of this manual.

APPROVED VENT TERMINATIONS	DURAVENT GS/PRO	SELKIRK DIRECT-TEMP	SECURITY SECURE VENT	AMP AMERIVENT DIRECT	METAL FAB DIRECT VENT	ICC EXCELDirect
VERTICAL CAP	46DVAVCH	1604802	SV4CGC	4DVC	4DVT	TM4VT
HORIZONTAL CAP	46DVAHC	1604804	SV4GHC	4DHC	4DHT	TM4HT
	46DVAHRCS					TM4DHT
	46DVAHSC					
SNORKEL		1604836		4D36C		TMST36

Just as with any other vented device, vertical vent rise creates draft (negative pressure) in the firebox as the exhaust gases heat up. If this draft becomes excessive, it can affect the performance or appearance of the fire. The **TWENTY6** fireplace includes air and exhaust restrictors that are used to balance the draft in the fireplace to the optimal level for installations where excessive draft might occur. The venting charts on pages 10 and 11 provide an easy means for determining whether your specific installation requires inlet air or exhaust restrictors or both. To make the determination about whether air or exhaust restrictors are needed, a venting chart worksheet is provided on page 12. Follow the instructions and fill in the worksheet for your particular installation. This will allow you to determine the recommended restrictor settings for your exact installation. Although this might appear to be a complicated process at first glance, it is really quite straight-forward and the result will be a fire that looks and performs as intended. Several examples of worksheet calculations are shown on page 13 to help guide you.

Please be sure to note that:

1. There are separate venting charts for Natural Gas and LP Gas. Refer to the appropriate chart for your fuel type to determine your specific restrictor requirements. The settings in the charts have been determined based on extensive testing.
2. Determine the total vertical vent rise and total horizontal vent run for your installation. All measurements are made from the center of the vent opening in the back of the fireplace.
3. If your fireplace will not be venting directly through an outside wall to a horizontal termination or if more than 30" of horizontal vent run is required, some vertical vent rise will be required for the fireplace to function and vent properly. Elbows will also be required for those installations. However, installations are limited to a maximum of four 90° elbows (or 45° elbow equivalents).
4. Note: Two 45° elbows equal one 90° elbow.
5. The recommended restrictor settings in the venting charts allow up to two 90° elbows (or 45° elbow equivalents) to be used without affecting the restrictor settings. Additional elbows will require that you calculate a new equivalent horizontal run for your installation to account for the additional flow resistance caused by the extra elbows. For the purposes of calculating the equivalent horizontal vent run, each additional 90° elbow is equivalent to three feet of horizontal vent run. The total horizontal vent run including elbow equivalents can not exceed 10 feet.
6. The maximum vertical vent rise can not exceed 20 feet.
7. There are two exhaust restrictors that are provided with your **TWENTY6** fireplace. They are labeled "A" and "B". The A restrictor provides less exhaust restriction than B.
8. An air restrictor plate is also provided with your fireplace. It is a ring with bendable tabs that can be set to adjust the amount of restriction in the air supply system. Once the appropriate number tabs are bent open (in accordance with the requirements for your installation), the plate is inserted between the fireplace and the vent starter pipe.

NATURAL GAS VENTING CHART

KEY

EXHAUST RESTRICTOR
A or B
NU = NOT USED



AIR RESTRICTOR
1— 6 TABS OPEN
NU = NOT USED

	0		1		2		2½		3		4		5		6		7		8		9		10	
	B	NU	B	NU	B	NU	B	NU	B	NU	B	NU	B	NU	B	NU	B	NU	B	NU	B	NU	B	NU
20	B	NU	B	NU	B	NU	B	NU	B	NU	B	NU	B	NU	B	NU	B	NU	B	NU	B	NU	B	NU
19	B	NU	B	NU	B	NU	B	NU	B	NU	B	NU	B	NU	B	NU	B	NU	B	NU	B	NU	B	NU
18	B	NU	B	NU	B	NU	B	NU	B	NU	B	NU	B	NU	B	NU	B	NU	B	NU	B	NU	B	NU
17	B	NU	B	NU	B	NU	B	NU	B	NU	B	NU	B	NU	B	NU	B	NU	B	NU	B	NU	B	NU
16	B	NU	B	NU	B	NU	B	NU	B	NU	B	NU	B	NU	B	NU	B	NU	B	NU	B	NU	B	NU
15	A	4	A	4	A	4	A	4	A	4	A	4	A	4	A	4	A	4	A	4	A	4	A	4
14	A	4	A	4	A	4	A	4	A	4	A	4	A	4	A	4	A	4	A	4	A	4	A	4
13	A	4	A	4	A	4	A	4	A	4	A	4	A	4	A	4	A	4	A	4	A	4	A	4
12	A	4	A	4	A	4	A	4	A	4	A	4	A	4	A	4	A	4	A	4	A	4	A	4
11	A	4	A	4	A	4	A	4	A	4	A	4	A	4	A	4	A	4	A	4	A	4	A	4
10	A	4	A	4	A	4	A	4	A	4	A	4	A	4	A	4	A	4	A	4	A	4	A	4
9			A	4	A	4	A	4	A	4	A	4	A	4	A	4	A	4	A	4	A	4	A	4
8			A	4	A	4	A	4	A	4	A	4	A	4	A	4	A	4	A	4	A	4	A	4
7			A	4	A	4	A	4	A	4	A	4	A	4	A	4	A	4	A	4	A	4	A	4
6			A	4	A	4	A	4	A	4	A	4	A	4	A	4	A	4	A	4	A	4	A	4
5			A	NU	A	NU	A	NU	A	NU	A	NU	A	NU	A	NU	A	NU	A	NU	A	NU	A	NU
4			NU	NU	NU	NU	NU	NU	NU	NU	NU	NU	NU	NU	NU	NU	NU	NU	NU	NU	NU	NU	NU	NU
3			NU	NU	NU	NU	NU	NU	NU	NU	NU	NU	NU	NU	NU	NU	NU	NU	NU	NU	NU	NU	NU	NU
2			NU	NU	NU	NU	NU	NU	NU	NU	NU	NU	NU	NU	NU	NU	NU	NU	NU	NU	NU	NU	NU	NU
1			NU	NU	NU	NU	NU	NU	NU	NU	NU	NU	NU	NU	NU	NU	NU	NU	NU	NU	NU	NU	NU	NU
0	NU	NU	NU	NU	NU	NU	NU	NU	NU	NU	NU	NU	NU	NU	NU	NU	NU	NU	NU	NU	NU	NU	NU	0

VERTICAL TERMINATIONS NOT ALLOWED

NOT ALLOWED

HORIZONTAL RUN IN FEET

VERTICAL RISE IN FEET

LP GAS VENTING CHART

KEY

EXHAUST RESTRICTOR
A or B
NU = NOT USED



AIR RESTRICTOR
1— 6 TABS OPEN
NU = NOT USED

	0	1	2	2½	3	4	5	6	7	8	9	10
20	B 3	B 3	B 3	B 3	B 3	B 3	B 3	B 3	B 3	B 3	B 3	B 3
19	B 2	B 3	B 3	B 3	B 3	B 3	B 3	B 3	B 3	B 3	B 3	B 3
18	B 2	B 3	B 3	B 3	B 3	B 3	B 3	B 3	B 3	B 3	B 3	B 3
17	B 2	B 2	B 2	B 2	B 2	B 2	B 2	B 2	B 2	B 2	B 2	B 2
16	B 2	B 2	B 2	B 2	B 2	B 2	B 2	B 2	B 2	B 2	B 2	B 2
15	B 2	B 2	B 2	B 2	B 2	B 2	B 2	B 2	B 2	B 2	B 2	B 2
14	B 1	B 2	B 2	B 2	B 2	B 2	B 2	B 2	B 2	B 2	B 2	B 2
13	B 1	B 4	B 4	B 4	B 4	B 4	B 4	B 4	B 4	B 4	B 4	B 4
12	B 1	B 4	B 4	B 4	B 4	B 4	B 4	B 4	B 4	B 4	B 4	B 4
11	B 1	B 4	B 4	B 4	B 4	B 4	B 4	B 4	B 4	B 4	B 4	B 4
10	B 1	B 5	B 5	B 5	B 5	B 5	B 5	B 5	B 5	B 5	B 5	B 5
9		B 5	B 5	B 5	B 5	B 5	B 5	B 5	B 5	B 5	B 5	B 5
8		B 5	B 5	B 5	B 5	B 5	B 5	B 5	B 5	B 5	B 5	B 5
7		B 5	B 5	B 5	B 5	B 5	B 5	B 5	B 5	B 5	B 5	B 5
6		B 5	B 5	B 5	B 5	B 5	B 5	B 5	B 5	B 5	B 5	B 5
5		B 4	B 4	B 4	B 4	B 4	B 4	B 4	B 4	B 4	B 4	B 4
4		A 4	A 4	A 4	A 4	A 4	A 4	A 4	A 4	A 4	A 4	A 4
3		A 3½	A 3½	A 3½	A 3½	A 3½	A 3½	A 3½	A 3½	A 3½	A 3½	A 3½
2		A NU	A NU	A NU	A NU	A NU	A NU	A NU	A NU	A NU	A NU	A NU
1		NU NU	NU NU	NU NU	NU NU	NU NU	NU NU	NU NU	NU NU	NU NU	NU NU	NU NU
0	NU NU	NU NU	NU NU	NU NU	NU NU	NU NU	NU NU	NOT ALLOWED	NOT ALLOWED	NOT ALLOWED	NOT ALLOWED	NOT ALLOWED

VERTICAL RISE (FEET)

HORIZONTAL RUN (FEET)

VERTICAL TERMINATIONS NOT ALLOWED

VENTING CHART WORKSHEET

A. FUEL TYPE: NATURAL GAS LP GAS (PROPANE)

B. TOTAL VERTICAL VENT RISE (MEASURED FROM HORIZONTAL CENTERLINE OF VENT OPENING ON THE BACK OF THE FIREPLACE TO THE HORIZONTAL CENTERLINE OF THE VENT CAP (FOR HORIZONTAL VENT CAPS) OR TO THE FLANGE ON THE CAP (FOR VERTICAL CAPS)): _____ FEET

C. TOTAL HORIZONTAL VENT RUN (MEASURED FROM THE VERTICAL CENTERLINE OF THE VENT OPENING ON THE BACK OF THE FIREPLACE TO THE FLANGE ON THE CAP (FOR HORIZONTAL CAPS) OR TO THE VERTICAL CENTERLINE OF THE CAP (FOR VERTICAL CAPS)): _____ FEET

NOTE: THE VERTICAL VENT RISE AND HORIZONTAL VENT RUN ARE THE OFFSETS IN THE LOCATIONS OF VENT CAP RELATIVE TO THE VENT OPENING ON THE FIREPLACE. VENT PIPE THAT RUNS AT 45° HAS BOTH A VERTICAL RISE AND HORIZONTAL RUN. SNORKEL CAPS HAVE BUILT-IN VERTICAL RISE THAT MUST BE COUNTED.

D. TOTAL NUMBER OF 90° ELBOWS: _____ NOTE: SNORKELS COUNT AS 2- 90° ELBOWS

E. TOTAL NUMBER OF 45° ELBOWS: _____

TERMINATION (CAP) TYPE: HORIZONTAL VERTICAL SNORKEL

VENT BRAND:

Simpson DuraVent GS/Pro[®] Selkirk Direct-Temp[®] Security Secure

Vent™

AmeriVent Direct™ Metal Fab Direct Vent ICC EXCELDirect

VENT CAP MODEL NO: _____ NOTE: SEE APPROVED VENT CAPS ON PAGE 8

EXHAUST AND AIR INLET RESTRICTORS CALCULATOR

A. Fuel Type _____

B. Total Vertical Vent Rise: _____ feet

C. Total Horizontal Vent Run (Actual): _____ feet

D. 90° Elbows Needed: _____

E. 45° Elbows Needed: _____

F. Total 90° Elbows Equivalent: $D + (E \times \frac{1}{2}) =$ _____

G. 90° Elbows in Excess of 2: $F - 2 =$ _____

H. Additional Horiz. Feet Equivalent: $G \times 3 =$ _____ feet

I. Horizontal Vent Run (Equivalent): $C + H =$ _____ feet

Find _____ Chart Settings for:

B. _____ feet Vertical Rise and I. _____ feet Horizontal Run
 (Equivalent).

VENTING CHART WORKSHEET EXAMPLES

A. Fuel:	Natural Gas
B. Total Vertical Vent Rise:	0 feet
C. Total Horiz. Vent Run (Actual):	0 feet
D. 90° Elbows Needed:	0
E. 45° Elbows Needed:	0
F. Total 90° Elbows Equivalent :	0
G. 90° Elbows in Excess of 2:	0
H. Additional Horiz. Feet Equivalent	0
<u>I. Total Horizontal Vent Run (Equivalent):</u>	<u>0</u>
Use Natural Gas Chart Settings for:	
0 feet Vertical Rise, 0 feet Horizontal Run.	
Exhaust Restrictor Used:	Restrictor Not Used
Air Restrictor Tabs Open:	Restrictor Not Used

A. Fuel:	LP Gas
B. Total Vertical Vent Rise:	1 feet
C. Total Horizontal Vent Run (Actual):	3 feet
D. 90° Elbows Needed:	2
E. 45° Elbows Needed:	0
F. Total 90° Elbows Equivalent:	$2 + (0 \times \frac{1}{2}) = 2$
G. 90° Elbows in Excess of 2:	$2 - 2 = 0$
H. Additional Horiz. Feet Equivalent:	$0 \times 3 = 0$
<u>I. Total Horiz. Vent Run (Equivalent):</u>	<u>3 + 0 = 3</u>
Use LP Gas Chart Settings for:	
1 feet Vertical Rise, 3 feet Horizontal Run.	
Exhaust Restrictor Used:	Restrictor Not Used
Air Restrictor Tabs Open:	Restrictor Not Used

A. Fuel:	Natural Gas
B. Total Vertical Vent Rise:	12 feet
C. Total Horiz. Vent Run (Actual):	0 feet
D. 90° Elbows Needed:	1
E. 45° Elbows Needed:	0
F. Total 90° Elbows Equivalent :	0
G. 90° Elbows in Excess of 2:	0
H. Additional Horiz. Feet Equivalent	0
<u>I. Total Horizontal Vent Run (Equivalent):</u>	<u>0</u>
Use Natural Gas Chart Settings for:	
12 feet Vertical Rise, 0 feet Horizontal Run.	
Exhaust Restrictor Used:	A
Air Restrictor Tabs Open:	4

A. Fuel:	LP Gas
B. Total Vertical Vent Rise:	10 feet
C. Total Horizontal Vent Run (Actual):	7 feet
D. 90° Elbows Needed:	2
E. 45° Elbows Needed:	2
F. Total 90° Elbows Equivalent:	$2 + (2 \times \frac{1}{2}) = 3$
G. 90° Elbows in Excess of 2:	$3 - 2 = 1$
H. Additional Horiz. Feet Equivalent:	$1 \times 3 = 3$
<u>I. Total Horiz. Vent Run (Equivalent):</u>	<u>7 + 3 = 10</u>
Use LP Gas Chart Settings for:	
10 feet Vertical Rise, 10 feet Horizontal Run.	
Exhaust Restrictor Required:	B
Air Restrictor Tabs Open:	5

A. Fuel:	Natural Gas
B. Total Vertical Vent Rise:	6 feet
C. Total Horizontal Vent Run (Actual):	6 feet
D. 90° Elbows Needed:	3
E. 45° Elbows Needed:	0
F. Total 90° Elbows Equivalent:	$3 + (0 \times \frac{1}{2}) = 3$
G. 90° Elbows in Excess of 2:	$3 - 2 = 1$
H. Additional Horiz. Feet Equivalent:	$1 \times 3 = 3$
<u>I. Total Horiz. Vent Run (Equivalent)</u>	<u>6 + 3 = 9</u>
Use Natural Gas Chart Settings for:	
6 feet Vertical Rise, 9 feet Horizontal Run.	
Exhaust Restrictor Required:	A
Air Restrictor Tabs Open:	4

A. Fuel:	LP Gas
B. Total Vertical Vent Rise:	2 feet
C. Total Horizontal Vent Run (Actual):	10 feet
D. 90° Elbows Needed:	2
E. 45° Elbows Needed:	0
F. Total 90° Elbows Equivalent:	$2 + (0 \times \frac{1}{2}) = 2$
G. 90° Elbows in Excess of 2:	$2 - 2 = 0$
H. Additional Horiz. Feet Equivalent:	$0 \times 3 = 0$
<u>I. Total Horiz. Vent Run (Equivalent):</u>	<u>10 + 0 = 10</u>
Use LP Gas Chart Settings for:	
2 feet Vertical Rise, 10 feet Horizontal Run.	
Exhaust Restrictor Used:	Restrictor Not Used
Air Restrictor Tabs Open:	3 ½

VENTING

The illustration below shows some of the many ways the **TWENTY6** fireplace may be installed in the home. This includes interior and exterior wall installations, corner installations and horizontal and vertical vent terminations.

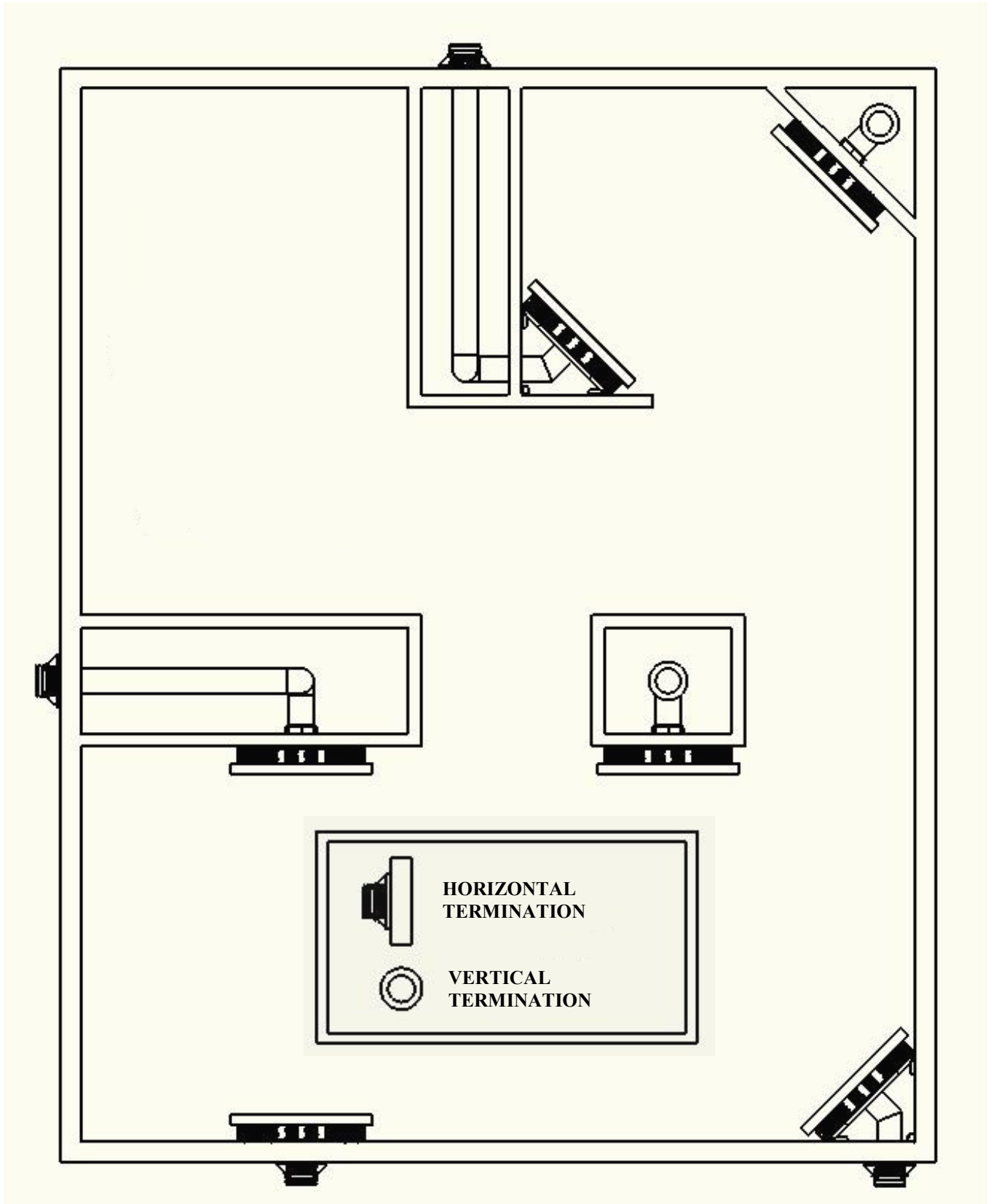

VENT TERMINAL CLEARANCES

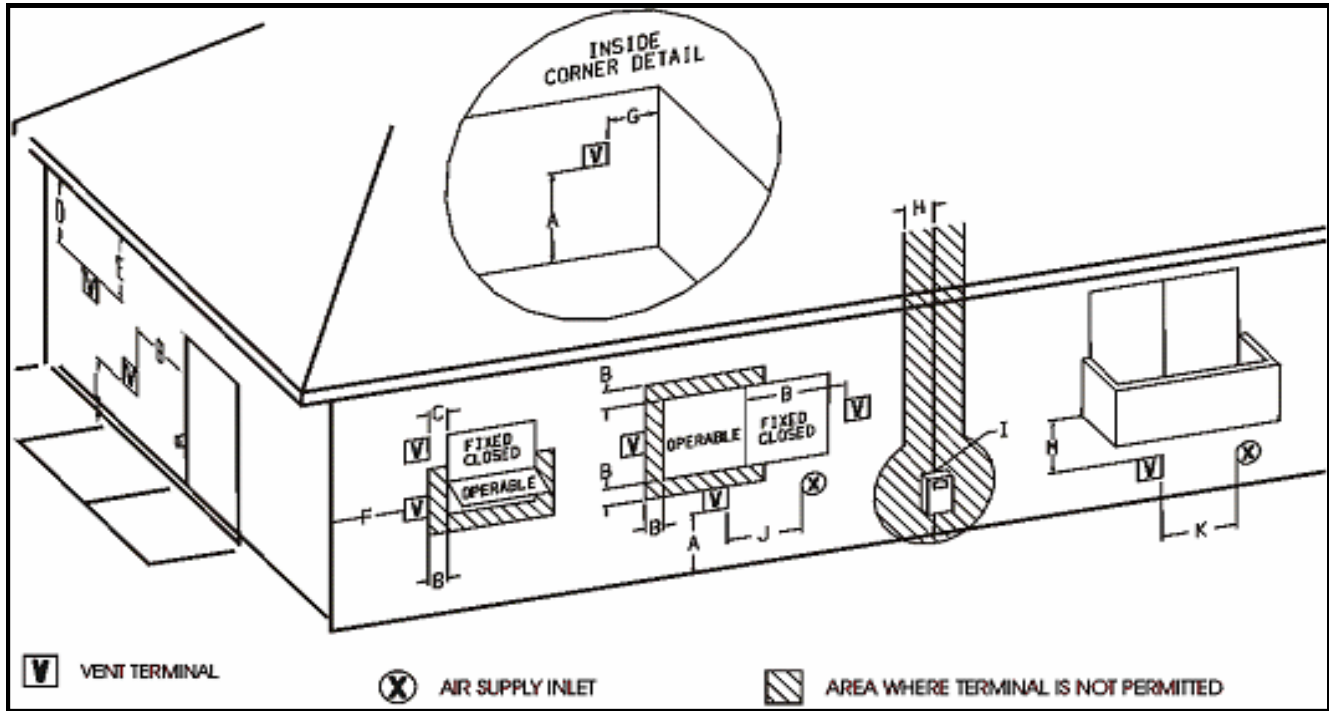

	Canadian Installations ¹	U.S. Installations ²
A = Clearance above grade, veranda, porch, deck or balcony	12 inches (30 cm)	12 inches (30 cm)
B = Clearance to window or door that may be opened	12 inches (30 cm)	9 inches (23 cm)
C = Clearance to a permanently closed window	See Footnotes 5 & 6	See Footnote 5
D = Vertical clearance to a ventilated soffit located above the terminal within a horizontal distance of 2 feet (61 cm) from the centerline of the terminal	See Footnotes 5 & 6	See Footnote 5
E = Clearance to unventilated soffit	See Footnotes 5 & 6	See Footnote 5
F = Clearance to outside corner	See Footnotes 5 & 6	See Footnote 5
G = Clearance to inside corner	See Footnotes 5 & 6	See Footnote 5
H = Clearance to each side of centerline extended above meter/regulator assembly	3 feet (91 cm) within a height of 15 feet (4.5 m) above the regulator/meter assembly	See Footnote 5
I = Clearance to service regulator vent outlet	3 feet (91 cm)	See Footnote 5
J = Clearance to non-mechanical air supply inlet to building or the combustion air inlet to any other appliance	12 inches (30 cm)	9 inches (23 cm)
K = Clearance to a mechanical air supply inlet	6 feet (1.83 m)	3 feet (91 cm) above if within 10 feet (3 m) horizontally
L = Clearance above paved sidewalk or paved driveway located on public property	7 feet (2.12 m)	See Footnote 5
M = Clearance under veranda, porch, deck or balcony	12 inches (30 cm) See Footnote 4	See Footnote 5

Footnotes

- 1 In accordance with the current CSA B419.1, Natural Gas and Propane Installation Code
- 2 In accordance with the current ANSI Z223.1 / NFPA 54, National Fuel Gas Code
- 3 A vent shall not terminate directly above a sidewalk or paved driveway that is located between two single family dwellings and serves both dwellings.
- 4 Permitted only if veranda, porch, deck or balcony is fully open on a minimum of two sides below the floor.
- 5 Clearance in accordance with local installation codes and the requirements of the gas supplier.
- 6 Dégagement conforme aux codes d'installation locaux et aux exigences du fournisseur de gaz.

Venting terminals shall not be recessed into a wall or siding.

ASSEMBLY & INSTALLATION

UNPACKING AND INSTALLING THE TWENTY6 WALL MOUNT FIREPLACE

The fireplace components are shipped in three cartons. By now, you will have opened the top of the first carton and removed the glass protector and this manual. The second carton contains the vent starter pipe, vent heat shields and air and exhaust restrictors. The third carton contains the fireplace surround.

1. Using the adjacent illustrations as a guide, first lift and remove Tube 1 from the carton containing the firebox. Carefully unpack the contents of the tube and set aside. This should include the bag of glass burner media, the remote control handset, a hardware bag and two relief doors with gaskets.
2. Next lift and remove Tube 2 from the carton. Carefully remove the contents of the tube. This includes the four decorative panels that will be attached to the fireplace during assembly.
3. Next, remove all remaining packing material from the carton.
4. Lift the firebox and the fireplace mounting plate as a unit up and out of the carton. The best place to lift is at sides. Remove the fireplace mounting template from the face of the firebox. You should now have all of the parts as shown in the illustration below.
5. Next, unpack the vent starter pipe (with attached gasket), the inner and outer telescoping vent heat shields and the air and exhaust restrictors from the second carton and set aside for later use.
6. Finally, unpack the fireplace surround from the third carton and set aside on a soft surface for later use.

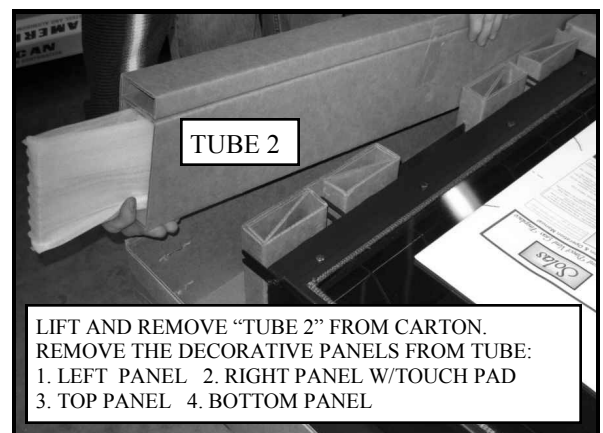
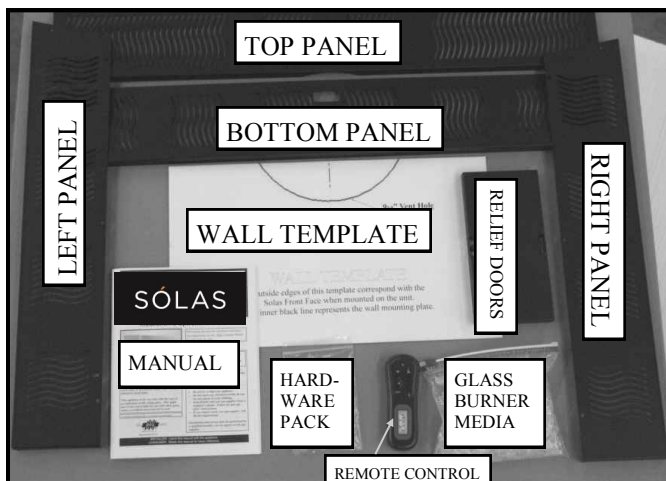
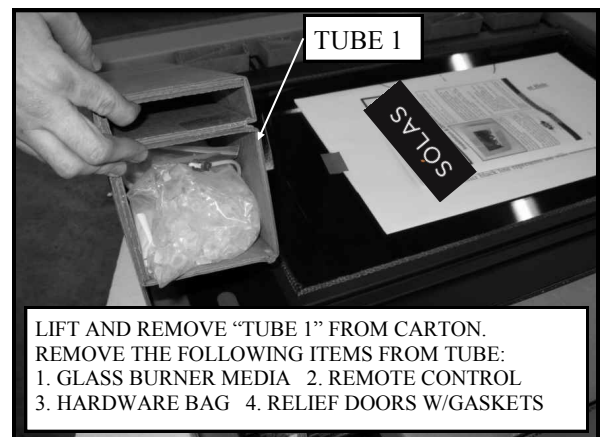
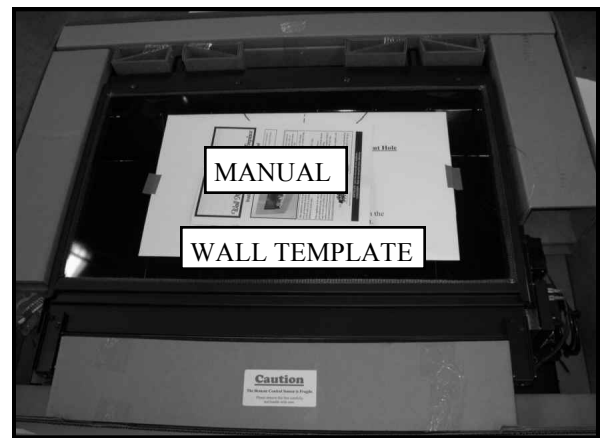
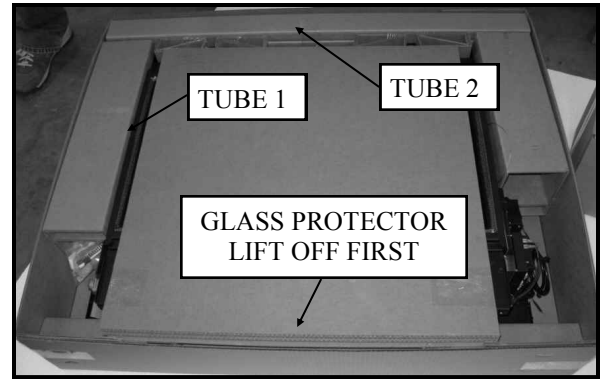

ASSEMBLY & INSTALLATION

Before you begin the fireplace mounting process there are several important installation requirements that must be met. Careful planning will make the installation easier to accomplish and will reduce the chances of encountering problems after you start.

1. The fireplace is designed to be wall-mounted using four lag bolts to secure the fireplace mounting plate to the wall structure. The mounts are located 16" on center and 24" on center to correspond with standard building construction. If your home has non-standard construction or the location you have chosen for the fireplace does not have wall studs that correspond to location of the fireplace mounts, modifications to the wall structure will be needed. It is critical that the four lag bolts that are provided for mounting the fireplace are firmly imbedded into the wall structure at all four locations.
2. A hole must be provided in the wall for the vent to pass through. The hole must be large enough to provide 1 1/2" clearance around the outside of the vent pipe and to allow for installation of the vent heat shields that are provided with the fireplace. Follow the hole size requirements that are provided below exactly to avoid problems. If the location you have chosen does not allow for 1 1/2" clearance to wooden framing in the wall, modifications to the wall structure must be made to obtain the needed vent pipe clearance.
3. All required minimum clearances to adjacent combustible materials (including side walls, ceiling and floor) must be achieved with the position you have chosen. See the clearance information on page 6. The listed clearances are measured from the outermost front edges of the fireplace surround and not from the fireplace body or mounting plate. In addition the requirements for clearance to combustible materials inside the house, there are specific requirements and limitations that must be met for the location of the vent terminal relative to doors, windows, corners, eaves, gas supply components and other structural elements of the house. Please see page 15 for those specific requirements. Again, plan the installation in advance to avoid problems.
4. The gas supply line must be located within a specific area behind the fireplace.

ASSEMBLY & INSTALLATION

Once you are certain that the location you have chosen meets all the necessary mounting and safety requirements, you can begin the installation.

1. Tape or pin the installation template to the wall in the position where the fireplace is to be mounted. Note: It is important that the fireplace is mounted in a level position. Use a spirit level placed on the cross-hairs in the upper mounting holes on the template and adjust the template position until the mounting holes are level. Refer to the adjacent illustration.
2. Next, carefully transfer the location of the two upper and two lower mounting holes that you will use for your installation. Use a sharp nail, awl or pin to pierce the template on the mounting hole cross-hairs to insure an accurate transfer to your wall.
3. Next transfer the location for the center of the vent pass-through hole on the wall. Also transfer at least one point on the diameter of the vent pass-through circle. This will make it easier to scribe the circle later.
4. Finally, transfer the location of the gas supply line.
5. Remove the template and circle the transferred locations with a pencil or marker.

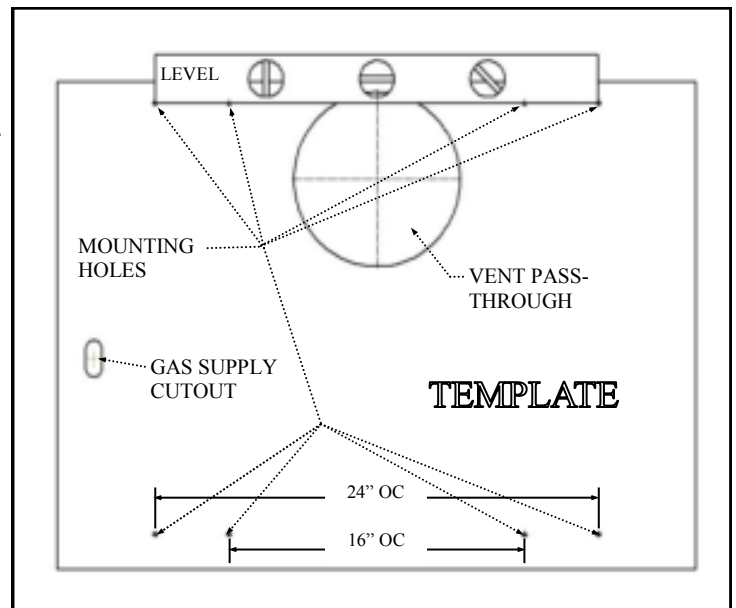

Vent Pass-Through (Parallel Wall Installation on an Outside Wall)

1. An unobstructed wall pass-through is required to allow for a safe installation of the fireplace vent components. This will necessitate removal of a portion of the interior wall covering (e.g., sheetrock or plaster and lath), outer wall sheathing and outer wall covering and any adjacent internal wall materials (like insulation).
2. Scribe a 9 5/8" diameter hole around the vent pass-through center mark using a compass.
3. Use a long drill (1/8" diameter) that is held square and level to the inside wall to transfer the vent pass-through center location from the inner wall covering through to the outer wall sheathing and outer wall covering.
4. Carefully cut the inner wall covering along the scribed line and remove the circular wall piece. Note: It is important to locate electrical wiring in the wall before beginning the installation process. An electrician should be consulted if there is any question about wiring locations. Failure to locate and protect wiring during the installation process may result in electrical shock or fire.
5. Remove any insulation materials from wall in the area defined by the pass-through hole.
6. Building codes in your area may require that you add blocking above and below the vent opening. The blocking should be above and below the 9 5/8" vent opening you made in the wall and should not obstruct that opening. The blocking should extend to adjacent wall studs.
7. Next, mark and cut a 9 5/8" diameter hole through the outer wall covering and sheathing using the locating hole you drilled in Step 2.
8. Follow the instructions included with the vent termination (cap) to remove the appropriate amount of outer wall covering (siding) or to install the vinyl siding shield if used. Do not install the chimney cap at this point.

ASSEMBLY & INSTALLATION

Vent Pass-Through (Parallel Wall Installation on an Interior Partition Wall)

1. An unobstructed wall pass-through is required to allow for a safe installation of the fireplace vent components. This will necessitate removal of a portion of the interior wall covering (e.g., sheetrock or plaster and lath), on both sides of the partition wall and any adjacent internal wall materials (like insulation).
2. Scribe a 9 5/8" diameter hole around the vent pass-through center mark using a compass.
3. Use a long drill (1/8" diameter) that is held square and level to the inside wall to transfer the vent pass-through center location from the inner wall covering through to the wall covering on the back side of the partition wall.
4. Carefully cut the inner wall covering along the scribed line and remove the circular wall piece. Note: It is important to locate electrical wiring in the wall before beginning the installation process. An electrician should be consulted if there is any question about wiring locations. Failure to locate and protect wiring during the installation process may result in electrical shock or fire.
5. Remove any insulation materials from wall in the area defined by the pass-through hole.
6. Building codes in your area may require that you add blocking above and below the vent opening. The blocking should be above and below the 9 5/8" vent opening you made in the wall and should not obstruct that opening. The blocking should extend to adjacent wall studs.
7. Next, mark and cut a 9 5/8" diameter hole through the wall covering on the back side of the partition wall using the locating hole you drilled in Step 2.
8. When installing the fireplace on a partition wall, the venting may be penetrating one or more interior walls, an exterior wall, the ceiling or the roof.
9. It is important to lay out the locations of all vent pass-through's before you begin the installation to insure that the venting will line-up correctly and that the walls and ceiling meet the needed clearances to the vent pipe.
10. The vent pass-through in the partition wall where the fireplace is mounted must be done in accordance with the instructions for a parallel wall installation on an outside wall, following steps 1 through 6.

Vent Pipe Heat Shields

Special telescoping double heat shields for the vent pipe are provided with the **TWENTY6** fireplace. These heat shields are a critical part of a safe installation. They are designed to protect combustible materials in the wall immediately behind the fireplace. The only exception to this is if the corner installation kit (Part Number CK-26-1) is used. With the corner kit, the heat shields are installed where the venting passes through the first adjacent side wall. See the instructions included with the corner kit for specific details.

ASSEMBLY & INSTALLATION

Gas Supply Line

1. Once the vent pass-through (or pass-through's) are finished, the gas supply line should be installed. The supply line should exit the wall that the fireplace will be installed on at the location specified on the installation template. We suggest the installation of a shut-off valve in the supply line between the wall and the connection to the fireplace. Your professional gas installer or local gas company will determine the specific requirements for the gas supply line as the requirements may vary in different locations. In every case, the installation must conform with local codes or, in the absence of local codes, with the *National Fuel Gas Code, ANSI Z223.1* or the *Canadian Installation Code, CAN/CGA B149*.

Installing the Fireplace Mounting Plate on the Wall

1. The fireplace mounting plate is attached to the wall structure using four 1/4" X 1 1/2" long lag bolts and large diameter washers that are provided with the fireplace. It is important to use the included hardware as the full weight of the fireplace is supported by the mounting plate.
2. Drill a 5/32" diameter pilot hole at each of the mounting hole locations that you marked using the template. The pilot holes should be the full depth of the lag bolts. Be sure that there is solid wood at each mounting location. If not, the wall should be reconstructed to provide the needed support.
3. Before the mounting plate can be lagged to the wall the two tabbed sections of the telescoping vent pipe heat shields that you set aside earlier must be attached to the mounting plate. Each heat shield half is held in place with three sheet metal screws (provided). The inner shield half (smaller diameter) is installed from the front of the mounting plate. Slide the inner heat shield half through the vent pipe opening in the mounting plate. Align the three tabs with the pilot holes in the mounting plate (as shown in the adjacent illustration) and install the three screws.
4. The outer vent pipe heat shield half (larger diameter) is installed on the rear of the mounting plate. Slip the outer shield half over the inner shield and align and install the three screws. See the adjacent illustration.
5. The fireplace mounting plate is now ready to be lagged to the wall structure.
6. With a helper pick up and align the mounting plate over the gas supply line and line up with the four mounting lag bolt pilot holes. These holes are in recessed bosses. Use either the 16" or 24" on center holes depending on the construction of the wall.
7. Using the lag bolts and washers provided with the fireplace, install the top lag bolts (with washers) first, followed by the lower ones. Use a 7/16" socket wrench to tighten the lag bolts.

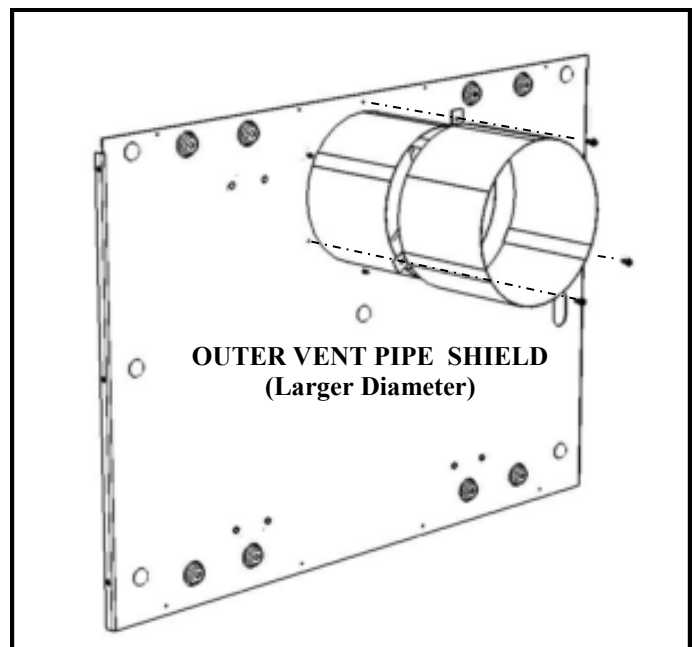
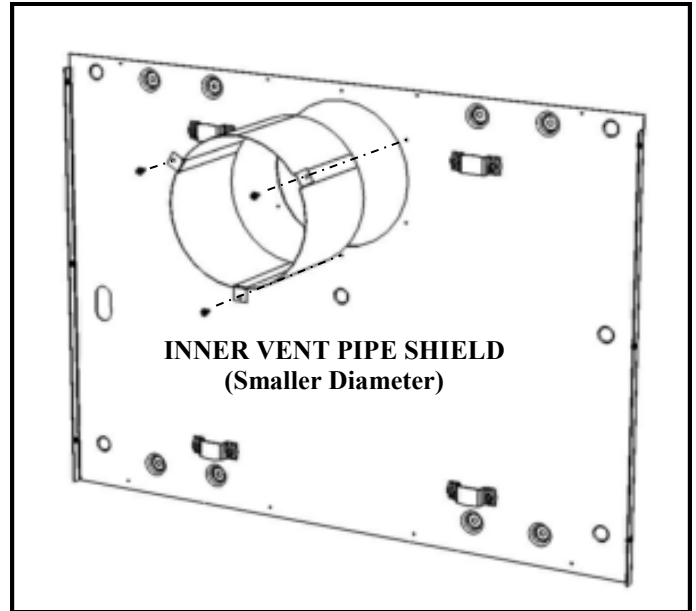

ASSEMBLY & INSTALLATION

Note: It may be helpful to put a light coating of dish or hand soap on the lag bolts to reduce resistance when tightening.

8. At this point, check to be sure that there is a $5/16$ " air gap between the entire flat back surface of the mounting plate and the wall surface. The gap is critical to a safe installation and if the gap is obstructed in any way, remove the obstruction before proceeding.
9. Next check that the brackets on the mounting plate that actually hold the fireplace are level, again using a spirit level. If the brackets are not perfectly level, you can adjust the right bracket by loosening the bracket fasteners and moving the bracket until it is level with the left bracket. Remember to tighten the bracket fasteners once you have achieved a level position.
10. The next step is to install the vent starter pipe onto the fireplace.
11. Remove the glass panel and glass frame assembly from the front of the firebox by loosening and removing the four glass frame fasteners that are located along the top edge of the glass frame.
12. While holding the glass panel and glass frame along the outer edges, tip the top of the glass frame forward a few inches.
13. Wrap your fingers around the frame and hold the glass and frame together while you lift the frame up and out of the lower glass retainer. Set the glass and frame assembly aside in a safe place.
14. Carefully place the fireplace with the front down on a protected floor.
15. At this point, it is necessary to determine whether your installation will require the addition of flow restrictors to the combustion air inlet system or the exhaust outlet or both. Refer to the venting section that starts on page 8 to make that determination.
16. If your installation does not require any restrictors, place the vent starter pipe gasket on the back of the fireplace aligning the holes in the gasket with the pilot holes on the rear of the fireplace.
17. Align the inner pipe of the vent starter pipe with the exhaust outlet pipe on the fireplace. The vent pipe will fit tightly over the fireplace pipe. Gently push the starter pipe on to the fireplace pipe until the outer pipe flange makes contact with the starter pipe gasket. Be sure that the holes in the starter pipe flange align with the gasket and pilot holes. When the flange contacts the gasket, install the four fasteners provided with the starter pipe.

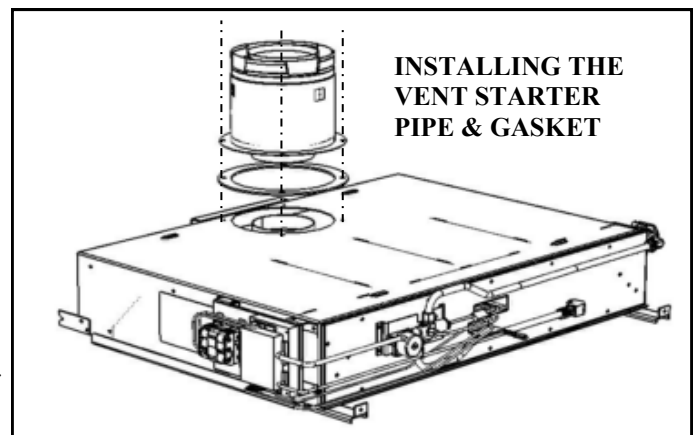
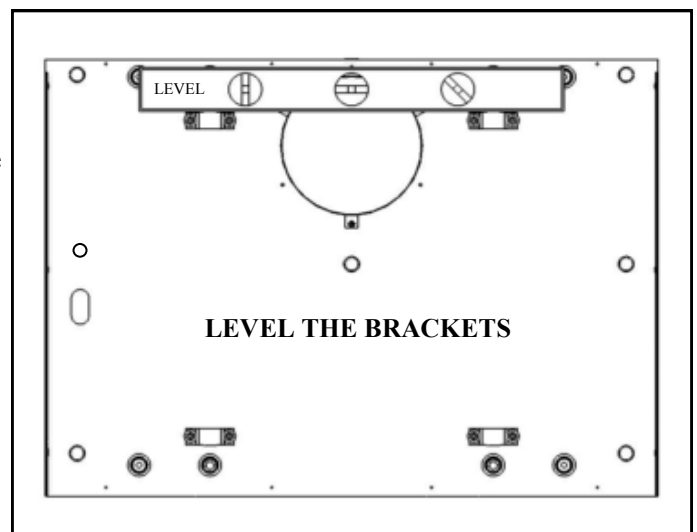
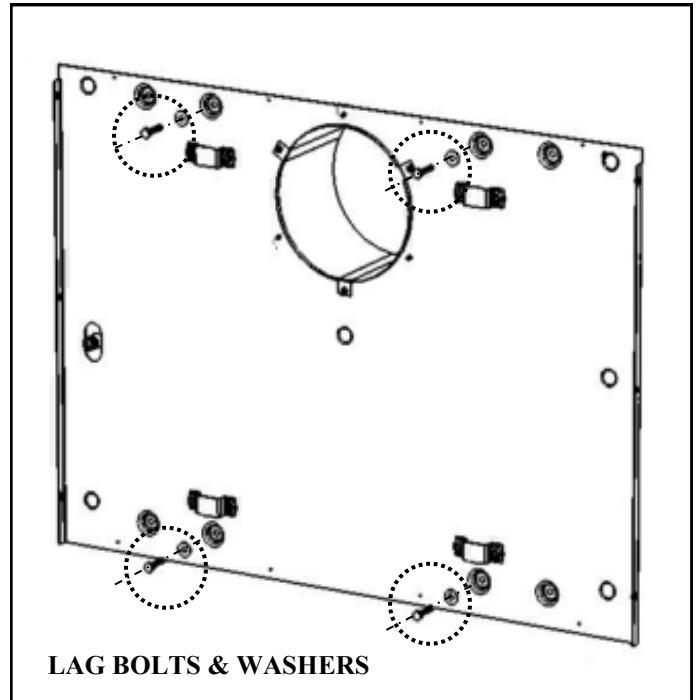

ASSEMBLY & INSTALLATION

18. If your installation does require an air restrictor or exhaust restrictor or both, these must be installed before you install the vent starter pipe. Again, refer to the venting information starting on page 8 to determine the specific restrictor requirements for your specific installation.
19. The exhaust restrictor is installed by placing it through the exhaust outlet pipe and resting it on the internal baffle in the firebox. It is held in place with a movable retainer clip. Simply hold the restrictor down against the baffle and push the retainer up and tighten screw to secure the restrictor. Note: Please take care to insure that the exhaust restrictor is centered in the exhaust outlet. Improper alignment could adversely affect the appearance of the flames. Refer to the adjacent illustrations for placement of the exhaust restrictor and clip.
20. If the air restrictor ring is required, first determine the number of tabs that must be bent open. Before bending any tabs, align the mounting holes in the ring over the four pilot holes on the back of the fireplace. When selecting the tabs to bend, it is important to maintain the most symmetrical pattern possible. The first tabs bent must be opposite each other and oriented horizontally. If only one tab is specified, orient the ring over the pilot holes so the split tabs are oriented horizontally and bend up two opposing half-tabs. Additional tabs should be evenly spaced relative to the first two. With the appropriate tabs bent, re-align the mounting holes in over the pilot holes keeping the proper orientation AND with the bent tabs facing away from the fireplace body.
21. Place the vent starter pipe gasket on the back of the fireplace aligning the holes in the gasket with the pilot holes on the rear of the fireplace.
22. Align the inner pipe of the vent starter pipe with the exhaust outlet pipe on the fireplace. The vent pipe will fit tightly over the fireplace pipe. Gently push the starter pipe on to the fireplace pipe until the outer pipe flange makes contact with the vent pipe gasket. Be sure that the holes in the starter pipe flange align with the gasket and pilot holes. When the flange contacts the gasket, install the four fasteners provided with the starter pipe.

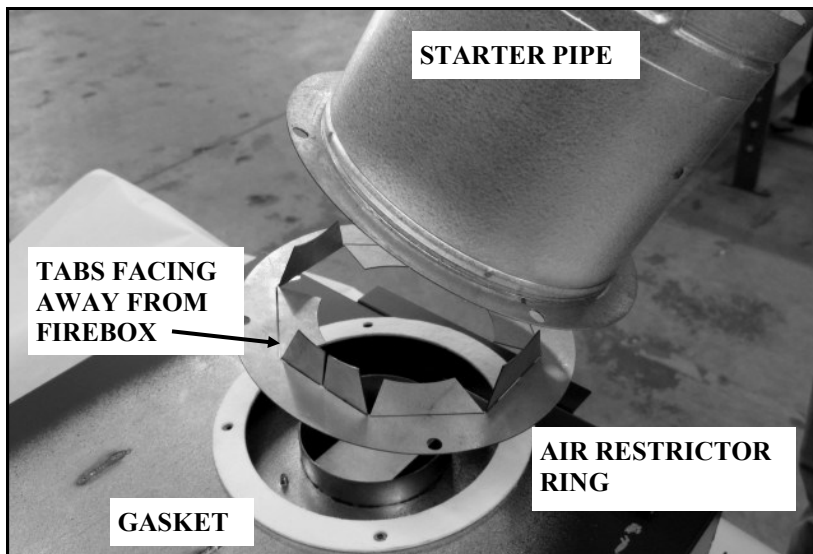
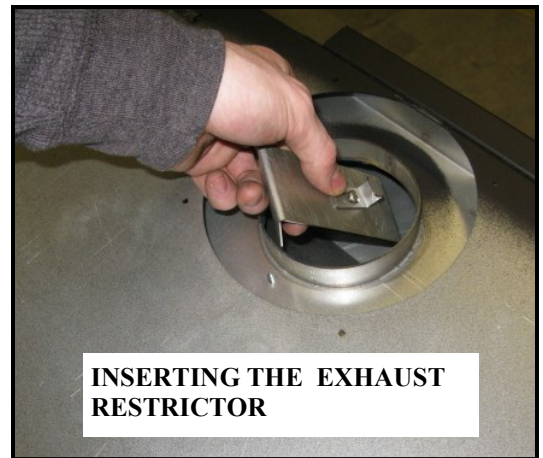

ASSEMBLY & INSTALLATION

23. You are now ready to install the fireplace on the mounting plate. This will require a helper as the fireplace is quite heavy. Lift the fireplace up and guide the vent pipe into the vent pipe opening in the mounting plate. The vent pipe must be at the highest location possible in the vent pipe opening (almost touching the inner vent pipe heat shield) to allow the mounting tabs on the rear of the fireplace to clear the top of the mounting brackets on the mounting plate. Refer to the adjacent illustration.
24. While looking in from the sides, guide the upper and lower mounting tabs on the back of the fireplace into the corresponding brackets on the mounting plate. When the tabs and brackets are aligned, push the fireplace down and in to engage the tabs in the brackets. Note: The weight of the fireplace is carried only on the top brackets. The bottom brackets function simply to keep the bottom of the fireplace from moving. Refer to the adjacent illustration.
25. If the fireplace is properly positioned on the brackets the vent starter pipe and vent heat shields should be concentric when viewed through the vent pass-through in the wall. Go outside and look in the hole to confirm this. If you are mounting the fireplace on a 45° partition wall, look in the pass-through using a mirror if needed. If the vent starter pipe and vent pipe heat shields do not appear to be concentric, check to be sure that the mounting tabs on the fireplace are all fully engaged in the brackets on the mounting plate and that the upper two tabs are sitting down on the upper brackets. If they are not, adjust the fireplace until they are.

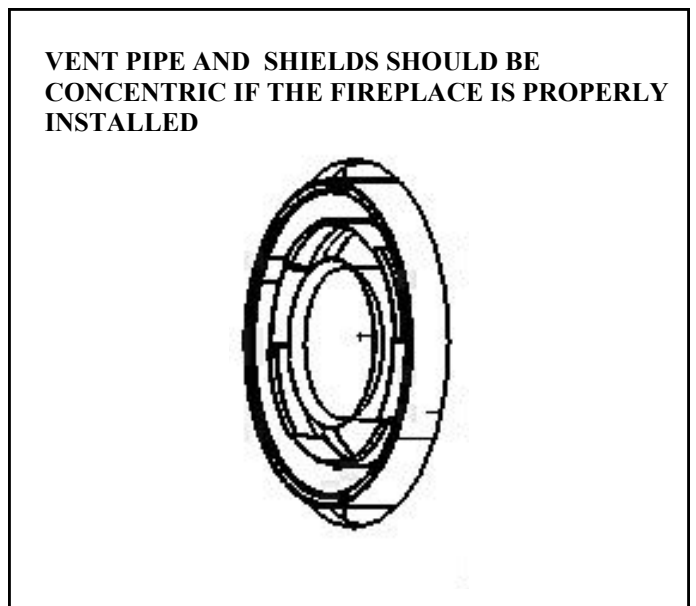
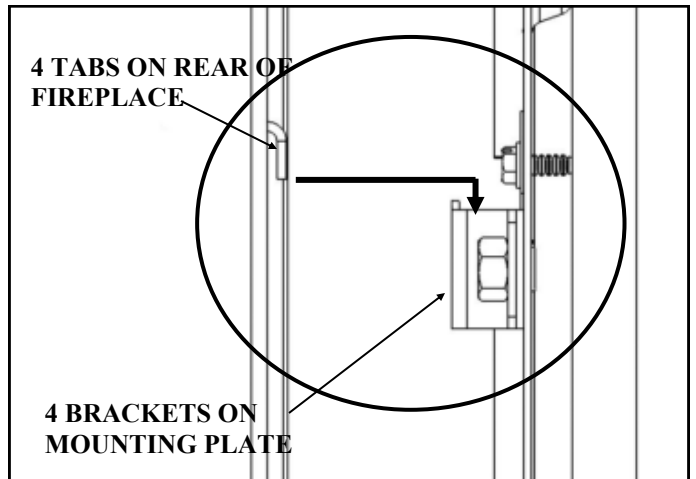
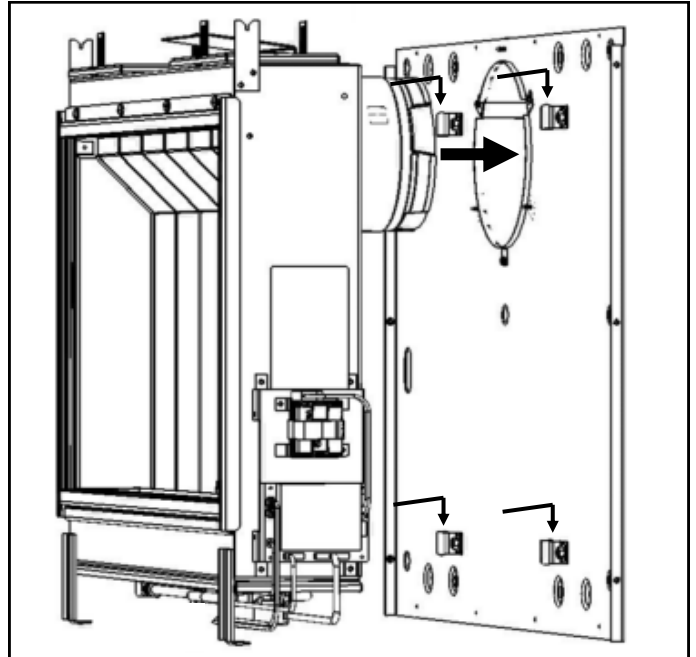

ASSEMBLY & INSTALLATION

Installing the Outer Vent Heat Shields and Vent Termination (Parallel Installation on Outside Wall)

1. Before you install the horizontal vent termination, you must first install the second halves of the two telescoping vent pipe heat shields. Each shield half simply slips over the half you previously attached to the fireplace mounting plate and can now be seen inside the vent pass-through in the wall.
2. Install the outer shield first and the inner second. Leave about 1-1/4" of the shields protruding past the house sheathing.
3. Install the horizontal vent termination (vent cap) by first removing the two mounting straps as they will not be used. Be sure the arrow on the cap (if present) is pointing up and reconfirm that all the vent cap location requirements per page 15 and the vent manufacturers requirements are met.
4. Slip the inner and outer vent termination pipes onto the vent starter pipe taking care to align the inner and outer pipes to prevent damage.
5. Slide the vent termination (cap) into the siding recess (or vinyl siding shield) until it bottoms out. Note: The rear surface of the vent termination will push the telescoping vent pipe heat shields inward. When the vent termination is in place the heat shields will just touch the rear surface of the termination.
6. Pull the vent cap away from the sheathing and install a small bead of non-hardening silicone sealer around the cap perimeter. Push the cap in place.
7. Install the mounting screws (included with the cap) to hold the vent cap to the sheathing. See the venting manufacturers instructions for the location of the mounting holes. Typical mounting hole locations are shown in the adjacent illustration. See the venting manufacturers instructions for more information or if using the vinyl siding shield.

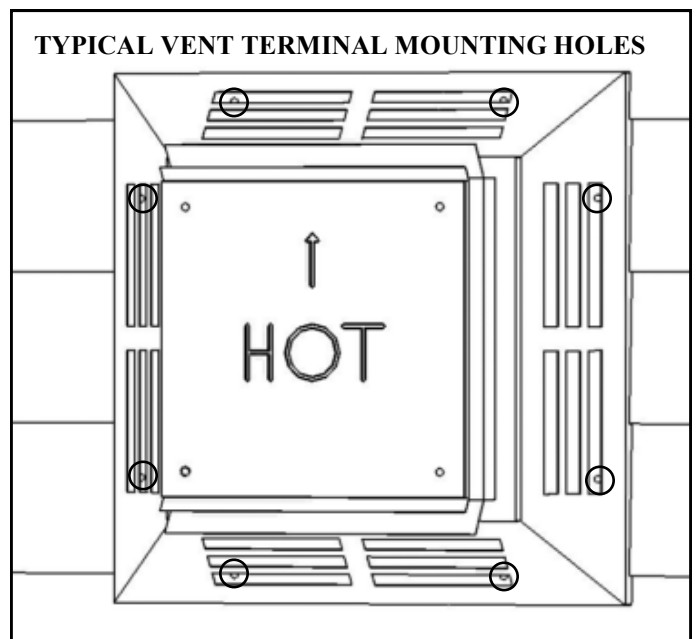
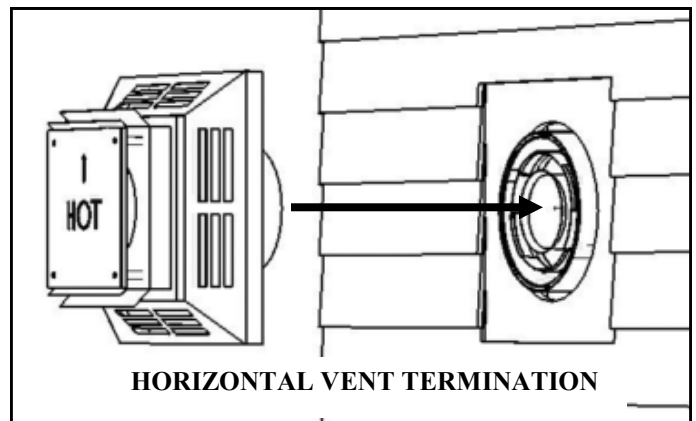
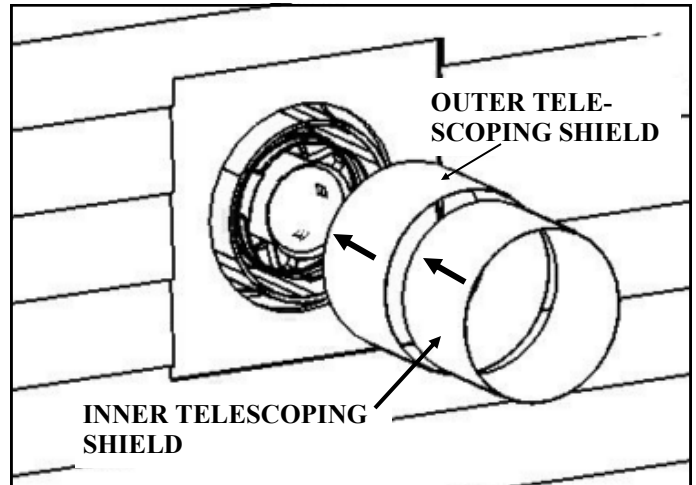

ASSEMBLY & INSTALLATION

Installing the Outer Vent Heat Shields (Partition Wall Installation)

1. Before you install the additional vent pipe and elbow(s) that will complete the venting installation, you must first install the second sections of the vent pipe heat shields to protect the combustible materials around the vent pipe pass-through in the partition wall that the fireplace is mounted on. Each shield half simply slips over the half you previously attached to the fireplace mounting plate and that can now be seen inside the vent pass-through in the partition wall.
2. Install the outer shield first and the inner second. Leave at least 2" of both shields protruding past the partition wall framing or wall covering. See the illustration on page 24.

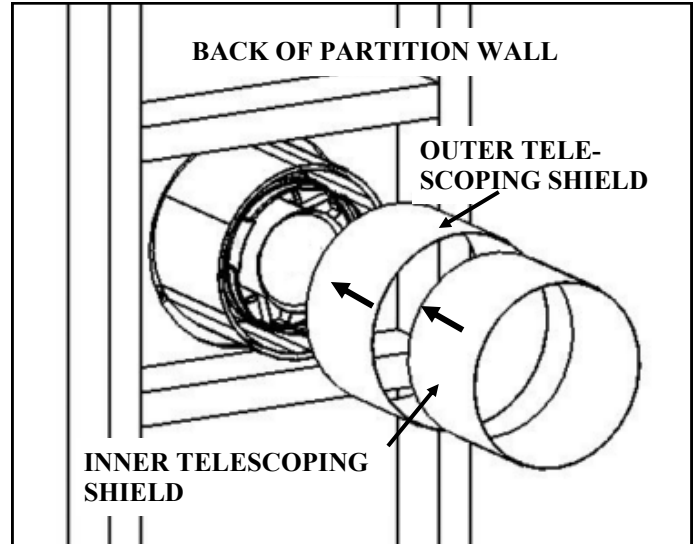

Vent Pipe and Vent Termination Installation (Partition Wall Installation)

1. The specific details of the vent configuration from the vent starter pipe on the fireplace to the horizontal or vertical vent termination (cap) when the fireplace is installed on an interior wall of the house will vary depending on the location of the fireplace on the wall, what is on the back side of the wall, where the vent termination will be located (roof or exterior wall) and on other code requirements for the location of the vent termination as shown page 15. However, the maximum vent length, measured along the centerline of the pipe, from the back of the fireplace to the start of the vent termination cannot exceed 30 feet, including a maximum of 20 feet of vertical rise and a maximum of 10 feet of horizontal run. If more than two 90° elbows (or equivalent 45° elbows) are needed for your installation, the maximum amount of horizontal run allowed is reduced. See the venting section starting on page 8 for specific information. It is important to plan the installation in advance so that you can accurately locate the any wall or ceiling pass-through's and the vent termination on the exterior wall or roof. The vent pipe sections are available only in certain increments of length and in adjustable length sections. Plan carefully before you start!
2. You will find it helpful to leave access to the area behind the partition wall to facilitate installation of the vent components. The pipe sections may have twist lock connections which will be difficult to execute without good access.
3. Be sure that the two vent pipe heat shields extend at least 2" beyond the rear side of the partition wall adjacent to the fireplace after the venting is installed.
4. Maintain a minimum 1 1/2" unobstructed air space around the vent pipe where it passes through other interior walls, the ceiling, the exterior wall or the roof.
5. Note: Vent manufacturer's instructions and some building codes may require the addition of blocking above and below all wall pass-through's, the addition of vent manufacturer supplied fire-stops, wall thimbles, attic insulation shields, interior trim collars, vent support brackets, or other components. Please check with the authority having jurisdiction in your area when planning the venting installation to determine the specific code requirements and exact venting components that are required for your installation.

ASSEMBLY & INSTALLATION

Gas Connection.

1. Verify that the gas type is correct for the fireplace by looking at the rating plate that is attached to the right side of the fireplace, adjacent to the control battery pack. Note: The fireplace is shipped from the factory equipped to burn the fuel listed on the rating plate. Fuel conversion in the field is not allowed.
2. The gas connection should now be made from the gas supply line to the inlet regulator on the fireplace. Use only a qualified gas installer to make the connection.
3. The fireplace is shipped from the factory with a 3/8" tube OD (male) connection.
4. The gas supply piping should have a separate gas shut-off valve and a 1/8" NPT plugged tapping upstream of the valve. We recommend installing a shut-off valve between the gas supply line where it penetrates the wall / fireplace mounting plate and the inlet to the regulator on the fireplace. This will allow gas to be shut-off to the fireplace by simply removing the fireplace surround to gain access to the shut-off valve.
5. The fireplace and its inlet regulator and main burner valve must be disconnected from the gas supply piping system during any pressure testing of that system at test pressures in excess of 1/2 psi (3.5kPa).
6. The fireplace must be isolated from the gas supply piping system by closing the gas shut-off valve during any pressure testing of the gas supply system at test pressures equal to or less than 1/2 psi (3.5kPa). After the gas supply has been connected, use a commercial gas leak detector or apply a soapy water solution to all the fittings to check for gas leaks. Never use a flame to test for leaks.

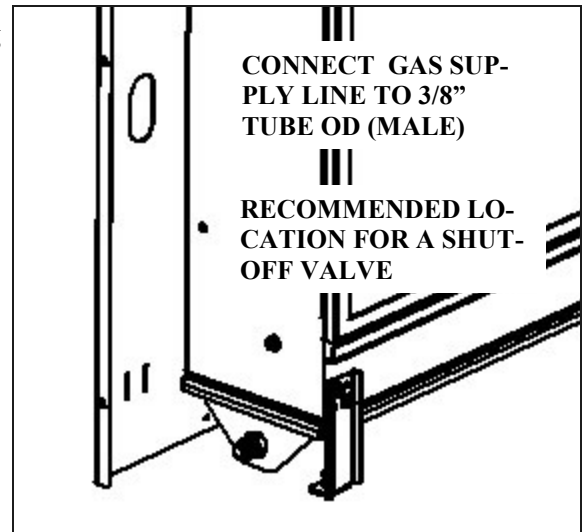

ASSEMBLY & INSTALLATION

Installing or Replacing the Batteries

1. The valve control module is powered by four “AA” batteries. The batteries are mounted within the Valve Receiver Module located on the right side of the fireplace attached to a drop-down mounting bracket for easy accessibility. Refer to the adjacent illustration.
2. Loosen the thumb screw on the module drop-down mounting bracket by turning counter-clockwise until the threads are fully disengaged from the base bracket.
3. Rotate the Valve Receiver Module and mounting bracket. Toward you 90 degrees.
4. Slide off the Battery compartment cover.
5. Install the 4 “AA” batteries, supplied, using the guides inside the battery pack to show you the correct battery orientation.
6. Replace the battery compartment cover. Rotate the Valve Receiver Module and mounting bracket into its home position and tighten the thumb screw to secure.
7. The remote handset is powered by three “AAA” batteries. The access panel is located on the back of the handset and simply snaps open to provide access to the battery compartment. Install the three batteries as shown on the label inside the remote control battery compartment.
8. Replace the remote handset access panel.

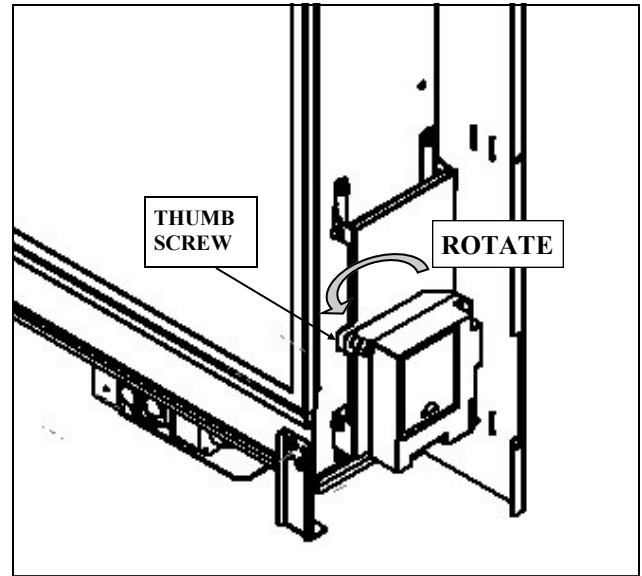

Placing the Burner Glass Media

The burner glass media poly-bag that you set aside when you unpacked the fireplace contains the correct amount of glass material to cover the burner. The entire contents of the bag should be evenly distributed over the burner tray.

1. Locate the burner in the fireplace. Refer to the adjacent illustration.
2. Carefully clip one corner of the poly-bag to form a pouring spout. The opening should be large enough to allow the glass media to flow but not so large that you can't control the flow.
3. You will notice that the burner surface is designed with turned-up edges that form a tray to hold the glass media.

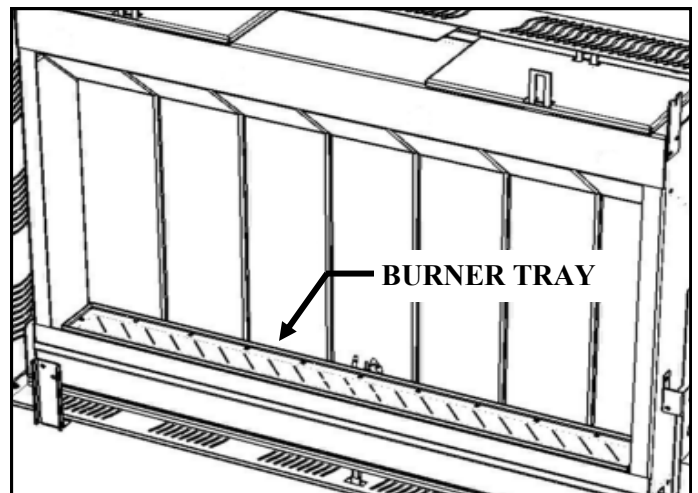

ASSEMBLY & INSTALLATION

- Starting at one end, pour the glass media onto the burner tray, keeping the pouring spout on the poly-bag toward the center of the burner to avoid spillage of glass pieces over the sides of the burner. See the adjacent illustrations.
- Once you have poured all of the glass burner media into the burner tray, carefully smooth the glass pieces out so they have a uniform depth over the entire surface of the burner. When the burner glass media is properly placed, it should look like the adjacent illustrations.
- Note: If a few pieces of glass escape over the edges of the burner tray during installation, it is not a problem. They will simply land in the area below the burner and will do no harm.

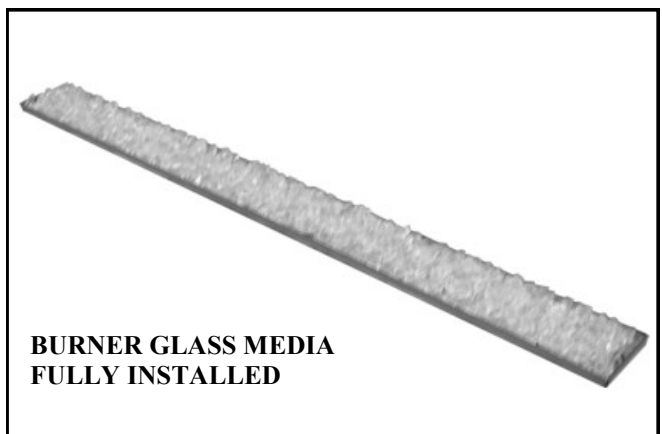
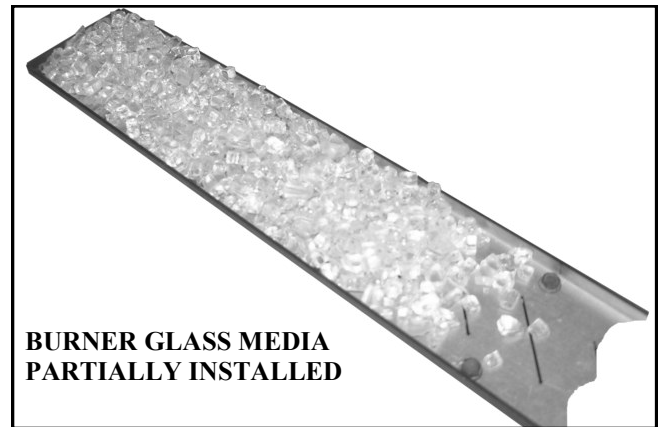

Relief Door Installation

- The two relief doors are shipped separated from the fireplace and must be installed on the top of the firebox at this point in the installation. Note: The relief doors include a gasket material that covers the full bottom surface. Use care in handling the relief doors to avoid damage to the gasket material.
- The first illustration below shows one of the two sets of relief openings and relief door retainers.
- The relief doors include line-up tabs that correspond to slotted retainers on the firebox.
- Tip each relief door enough to allow the rear line-up tab to engage the rear retainer slot. Refer to the second illustration below.
- Rotate the front edge of each relief door so they line-up over front retainers.
- Gently spring the front forward so it will allow the relief door front line-up tab to engage on the retainer. Refer to the first illustration on the top of page 29.
- The relief doors should be able to move up and down freely on the retainers if properly installed.
- When the relief door installation is complete, the doors should be in the full down position. Refer to the second illustration on the top of page 29.

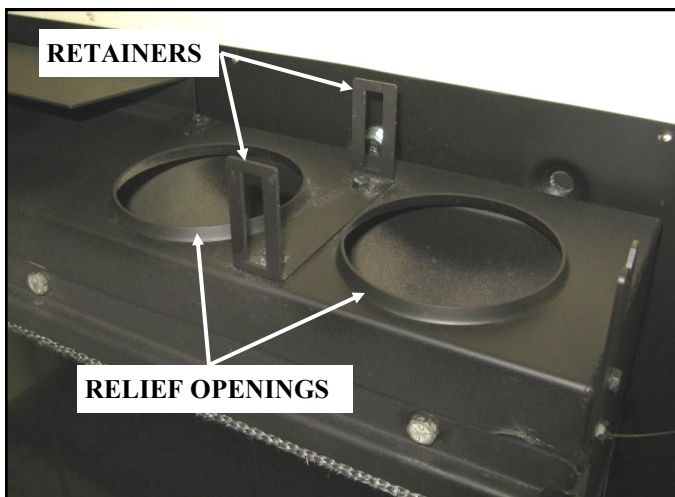

ASSEMBLY & INSTALLATION



Installing the Front Glass Panel and Frame

After burner media and relief doors been installed, the next step is to replace the front glass panel and frame.

1. Carefully pick up the glass and glass frame assembly by grasping the sides of the frame and using your thumbs and fingers to hold the glass in place within the gasket and frame.
2. With the glass frame (and glass) held at a slight angle (leaving room for your fingers between the frame and the firebox) insert the bottom edge of the frame into the frame retainer located on the bottom front of the firebox. Take care to center the frame from left to right.
3. Once the bottom edge is in place, move your fingers out of the way and press the top of the frame against the firebox while pushing down to be sure the frame is fully engaged in the frame retainer.
4. Hold the frame in place with one hand and insert the four glass frame fasteners along the top edge of the glass frame. Tighten the fasteners until they are hand-tight.
5. Tighten each fastener 1/2 turn at a time, working from one side to the other, until the glass frame has made contact with the firebox face along the entire top edge. Do not over-tighten the fasteners as this can put excessive stress on the glass.

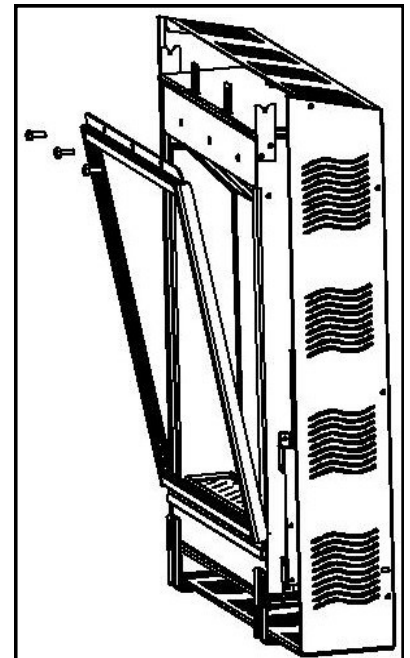

ASSEMBLY & INSTALLATION

Installing the Outer Panels

1. The four outer decorative panels are secured to the fireplace with philips head screws. The top and bottom panels are secured to the fireplace mounting plate with sheet metal screws. All other screws are philips head machine screws.
2. Install the top panel first. Align the three holes along the rear edge of the panel with pilot holes along the top edge of the fireplace mounting plate.
3. Insert and tighten the three sheet metal screws. A magnetic nut driver is helpful.
4. Install the left side panel next. Align the three holes along the rear edge of the panel with the PEM nuts along the edge of the fireplace mounting plate. Insert the three philips head screws but do not fully tighten.
5. Locate the fastener hole at the top front edge of the left side panel and align with the PEM nut in the front of the top panel. Insert the philips head screw.
6. Make sure the edges of the panel are aligned with the edges of the top panel and mounting plate and tighten all four philips head screws.
7. Position the right side panel so it aligns with the three PEM nuts on the mounting plate and the front PEM nut on the top panel. Align the rear and top panel edges with the adjoining parts and insert and tighten the four philips head screws.
8. Install the bottom panel next. Guide the rear flange on the panel upward until the mounting holes in the flange line up with the pilot holes in the mounting plate.
9. Attach the panel to the mounting plate using sheet metal screws along the back edge of the panel. Note: It may make installation of the sheet metal screws easier if you remove the two lower surround mounting brackets from the front of the fireplace. A magnetic nut-driver will also be helpful.
10. Attach the bottom panel to the side panels by aligning the fastener holes in the bottom panel with the PEM nuts in the front corners of the bottom flanges on the side panels. Insert and tighten the two philips head screws.
11. Reinstall the lower surround brackets if you removed them by inserting and tightening the two sheet metal screws in each bracket.
12. Only trim kit(s) supplied by the manufacturer shall be used in the installation of this appliance.

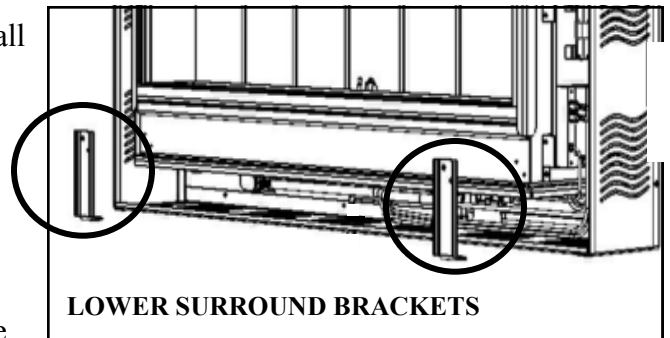
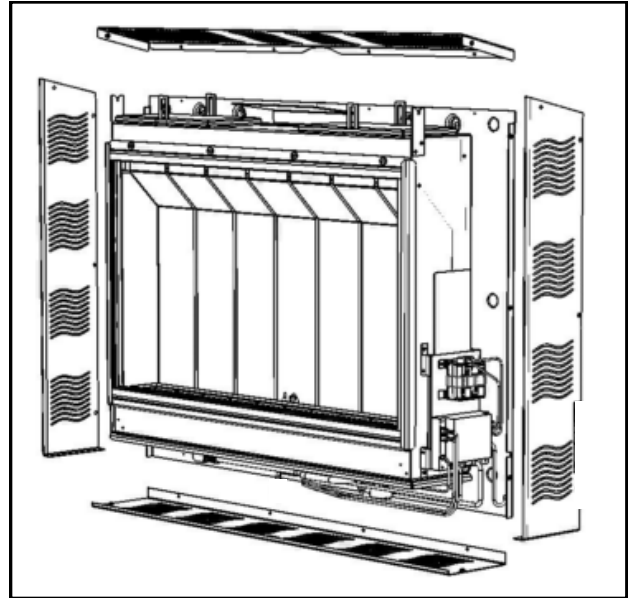

ASSEMBLY

Installing the Fireplace Surround with Integrated Screen

The decorative surround with integrated screen for the fireplace is held in place by four brackets. Two are located on the top of the fireplace and two on the bottom. There are mating brackets and catch plates on the surround itself. Refer to the adjacent illustrations when installing the surround.

1. Unpack the surround with integrated screen from shipping box.
2. With a helper, lift the surround with integrated screen up and identify the top by looking for the vertical brackets that are visible from the rear of the surround.
3. Move the surround with integrated screen into place, generally centering the surround opening over the glass panel. Keep the bottom of the surround tipped slightly away from the fireplace.
4. While looking behind the surround with integrated screen, guide the two surround brackets onto the forward detent of the mating brackets on the fireplace top. You might find it easier to engage one bracket and then the other. Lower the surround until both bracket sets are fully mated.
5. Carefully push the top of the surround with integrated screen so that the surround brackets slide into the rear detent of the mating brackets on the fireplace top.
6. Carefully swing the bottom of the surround with integrated screen toward the base of the fireplace until the catch plates on the bottom flange of the surround are aligned with the spring loaded plungers on the bottom flanges of the lower surround mounting brackets.
7. To remove the surround with integrated screen, pull the bottom edge of the surround outward to disengage the spring loaded plungers and then lift the top up and off the upper brackets.
8. To prevent damage to the surround with integrated screen, always set the surround with integrated screen in a safe place while it is removed from the fireplace.

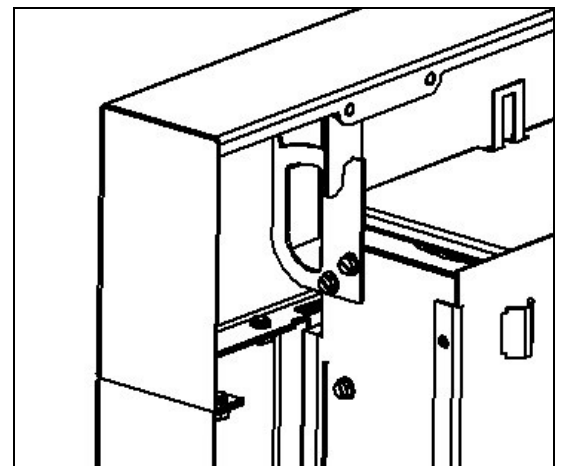
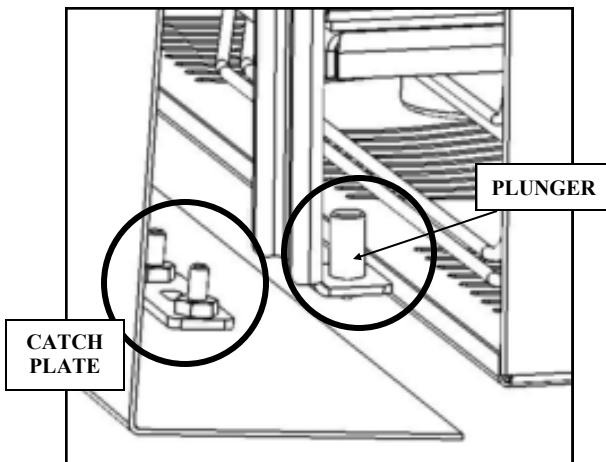
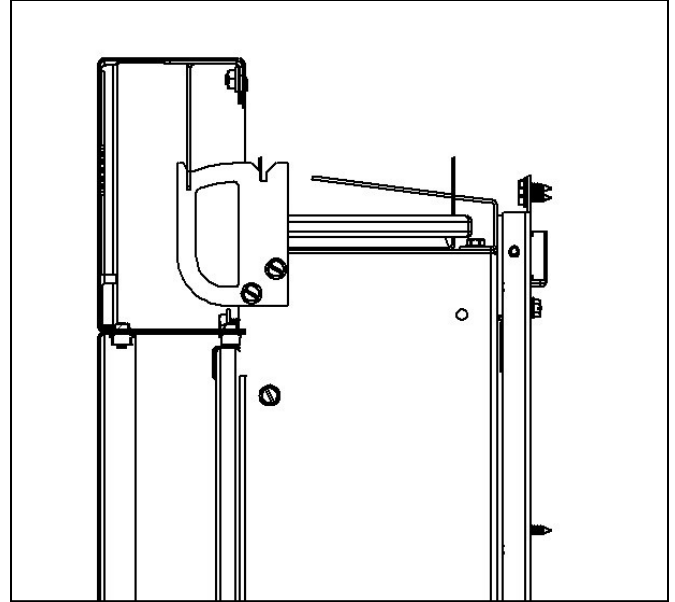

UPPER SURROUND BRACKETS WHEN PROPERLY MATED

LIGHTING AND OPERATION

WARNING: If you do not follow these instructions exactly, a fire or explosion may result causing property damage, personal injury or loss of life.



When lighting this appliance, follow these instructions exactly.

- A. This appliance is equipped with an ignition device that automatically lights the pilot. Do not try to light the pilot by hand.
- B. BEFORE OPERATING THE BURNER SYSTEM, smell around the appliance area for gas. Be sure to smell next to the floor because some gas is heavier than air and will settle on the floor.









WHAT TO DO IF YOU SMELL GAS

- Do not try to light the appliance.
 - Do not touch any electric switch; do not use any telephone in your building.
 - Immediately call your gas supplier from a neighbor's telephone. Follow the gas supplier's instructions
 - If you cannot reach your gas supplier, call the fire department.
- C. Use only your hand to operate the gas controls. Never use tools. If a knob will not push in or turn by hand, don't try to repair it, call a qualified service technician. Force or attempted repair may result in a fire or explosion.
 - D. Do not use this appliance if any part has been under water. Immediately call a qualified service technician to inspect the appliance and to replace any part of the control system which has been under water.

OPERATING INSTRUCTIONS

1. STOP! Read the safety information above on this label.
2. This appliance is equipped with an ignition device that automatically lights the pilot. Do not try to light the pilot by hand.
3. Using the Remote Handset, or the optional Wall Switch, push the "OFF"  button until you hear an audible signal to insure the appliance is Off.
4. Wait five (5) minutes to clear out any gas. Then smell for gas including near the floor. If you smell gas, STOP! Follow "B" in the safety information above. If you don't smell gas, proceed to step 5.
5. Using either the Remote Handset, or the optional Wall Switch, simultaneously press the "ON"  and "High Flame"  buttons. An audible signal confirms the start sequence has begun.
6. Continuing beeps confirm the ignition is in process. Once lighting the pilot flame should appear as shown in Fig.2. Once the pilot is confirmed, the main burner ignites on high.

NOTE: If the pilot does not stay lit after several tries, proceed to step 9.

7. Use the flame height adjustment buttons on either the Remote  Handset or the optional Wall Switch to adjust the flame. Press the   button twice to decrease the flame height to its lowest setting, press the  button twice to increase flame height to the highest setting. Pressing the  or  button once will modulate the flame to intermediate  settings. The Remote Handset can also be used to control the appliance thermostatically.
8. Press and hold the  button on the Remote Handset or optional Wall Switch to set the appliance to Pilot flame only.
9. If the appliance will not operate, follow the instructions "TO TURN OFF GAS TO THE APPLIANCE" and call your gas service technician or gas supplier.

TO TURN OFF GAS TO THE APPLIANCE

1. To turn off gas to the appliance, push and release the "OFF"  button on either the Remote Handset or on the optional Wall Switch. You will hear an audible signal confirming the off setting.
2. TO TURN OFF THE GAS SUPPLY TO THE APPLIANCE, close the shut-off valve on the gas supply line to the appliance.

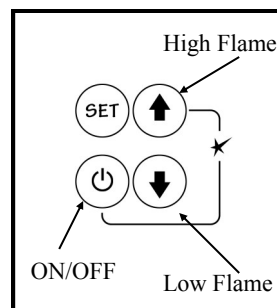

FIG. 1

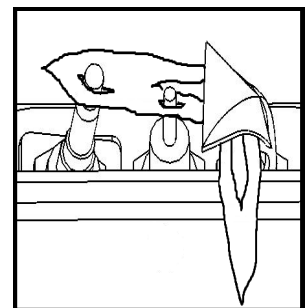

FIG. 2

Maxitrol Remote Control

Please note the images of the remote handset on pages 34-39 of this manual depict the Maxitrol GV60 Remote Control, although the profile of the remote depicted is different from the one included with your fireplace, the buttons and operation of the remote is the same.

Follow the instructions in the manual using these guidelines:





- The large flame button  as seen in the manual's images is equivalent to the up arrow on your remote 
- The small flame button  as seen in the manual is equivalent to the down arrow on your remote 



Image of the Remote Control
in the Manual



Image of the Remote Control
for your Fireplace

LIGHTING AND OPERATION

OPERATING YOUR FIREPLACE FOR THE FIRST TIME

When operating your new fireplace for the first time, some vapors may be released due to the burning of curing compounds used in the manufacture of the appliance. They may cause a slight odor and could cause the flames to be the full height of the firebox, or even slightly higher, for the first few hours of operation.

It is also possible that these vapors could set off any smoke detection alarms in the immediate vicinity. These vapors are quite normal on new appliances. We recommend opening a window to vent the room. After a few hours use, the vapors will have disappeared and the flames will be at their normal height.

FLAME SUPERVISION DEVICE

For your safety, this appliance is fitted with a flame supervision device which will shut-off the gas supply if, for any reason, the pilot flame goes out. This device incorporates a fixed probe, which senses the heat from the pilot flame. If the probe is cool, the device will prevent any gas flow unless manually lighting the pilot. See full lighting instructions. Periodically check the pilot and burner

LIGHTING, OPERATION AND RATING INFORMATION

The Lighting, Operation and Rating information is located on a plate under the firebox.

To access the plate, remove any fret or access panel and grab the plate and slide it out to read it. There is important information on both sides of the plate.

WARNING

DO NOT ATTEMPT TO TOUCH THE DATA PLATE WHILE THE FIREPLACE IS STILL HOT!
Let the fireplace cool first before touching it.

SERVICING

If any attention is required for your appliance, contact your dealer quoting the model number. It will be helpful if the appliance's serial number can also be quoted. This number is on the rating plate, which is located under the burner. The replacement parts are shown at the end of this manual. Please always quote the part number and description when requesting spare parts.

FIREPLACE CONTROL DEVICES

There are two ways to control your fireplace.

1. Thermostatic Remote Control
2. Optional Wall Switch

The Thermostatic Remote Control can be programmed to function automatically—see pages 9–13.

The Wall Switch (optional) can be used to turn on, off and to increase or decrease the flame height—see M46-505 — Wall Switch Kit.

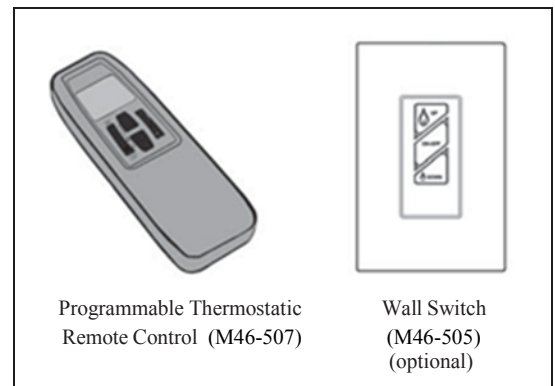

NOTE: The remote control in the AUTO mode will override the optional wall switch.



MAXITROL GV60 CONTROL SYSTEM

HOW TO TURN YOUR FIREPLACE OFF (including pilot)

Familiarize yourself with each of these methods before operating your fireplace.

Handset and Wall Switch: Press and hold the OFF button for a second (either on the handset or the wall switch).

If the flames are on, they go down and you hear the valve motor wind down. You hear a clunk and a beep indicating that the valve has received the signal from the remote control.

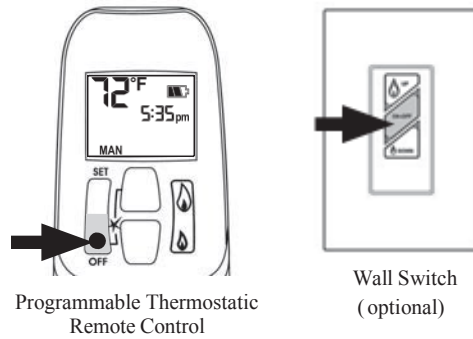

How to Ensure Your Fireplace Cannot Be Turned ON Inadvertently

You can use the following method to ensure that your fireplace will not turn on when you don't want it on.

First, ensure your fireplace is turned off—including the pilot—and cold BEFORE going ahead.

- Close the shut-off valve on the gas supply line to the appliance.
- Remove all batteries from the receiver as well as the battery from the handset.

Automatic Shut-Off (in certain conditions)

Your fireplace's remote control is equipped with an automatic shut-off mechanism which is activated in certain conditions. See page 13 in the *Remote Control Operation* section for a description of this feature.

NOTE: Before using the remote control system for the first time, the receiver and the handset are synchronized at the factory. See the section *Remote Control Initial Set-up* on page 39 of this manual if the receiver and handset lose synchronization.

IMPORTANT: BEFORE YOU BEGIN, please note that on this system, the settings of time, temperature and automatic ON/OFF can only be programmed when the function display is flashing. Be patient when programming as it can take a few seconds to set.

MAXITROL GV60 CONTROL SYSTEM

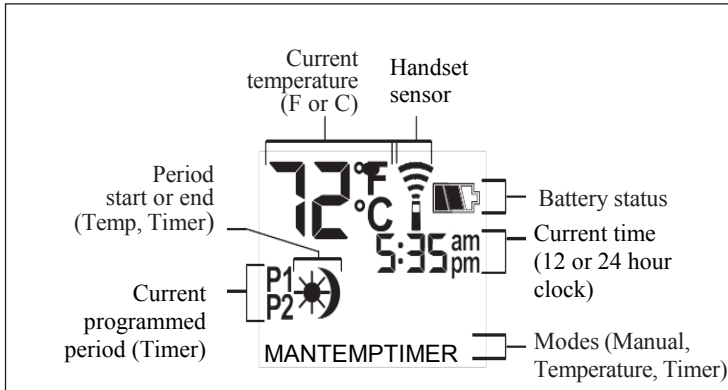

Display Overview

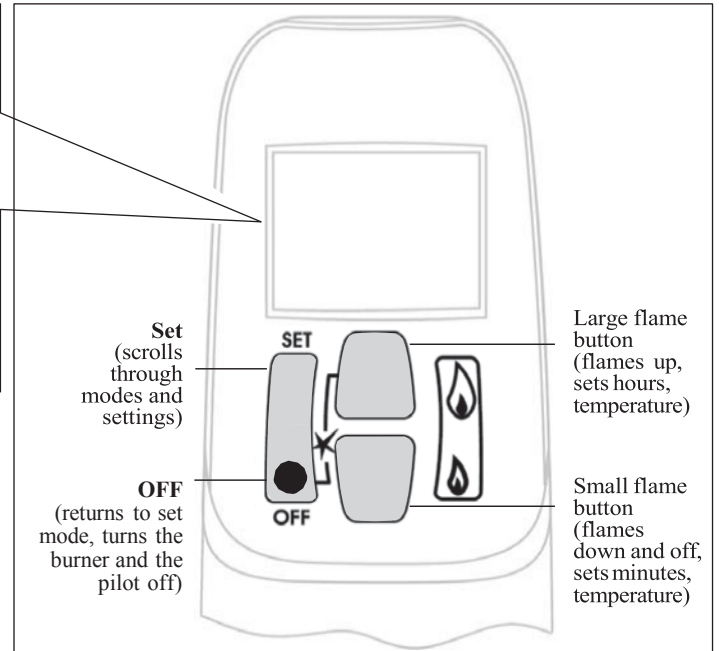

Handset Overview

Note: In the TEMP or TIMER modes, the remote handset senses the room temperature and adjusts the flame accordingly.

To communicate, the handset should be within 15 feet (4.5 meters) of the fireplace.

Do not leave the handset on the hearth, mantel, or on top of the fireplace.

TO TURN ON APPLIANCE

CAUTION

When pilot ignition is confirmed, motor turns automatically to maximum flame height.

- On the valve, turn MAN knob on the ON, full counterclockwise  position.

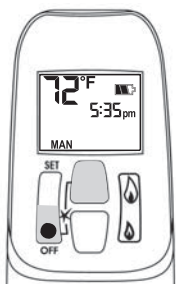

- Simultaneously press the OFF and  (large flame) buttons until a short beep confirms the start sequence has begun; release buttons.
- Continuing beeps confirm the ignition is in process.
- Once pilot ignition is confirmed, there is main gas flow.
- After main burner ignition the handset will automatically go into manual (MAN) control mode.

TO TURN OFF APPLIANCE

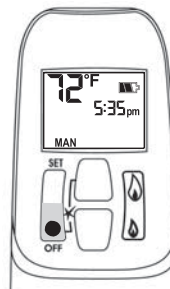

- Press OFF button.

When the pilot is off, it will take 2 minutes before it can be lit again.

STANDBY MODE (Pilot Flame)

- Press and hold  (small flame) to set appliance at pilot flame

FLAME HEIGHT ADJUSTMENT

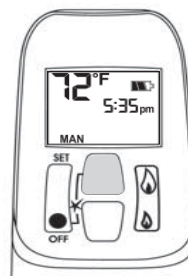



- In standby mode: Press and hold  (large flame) button to increase flame height.

MAXITROL GV60 CONTROL SYSTEM

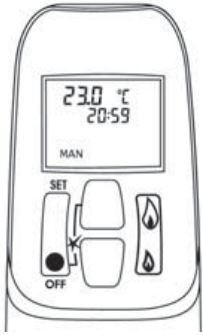
MAN



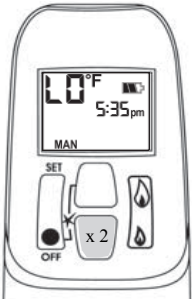

- Press and hold  (small flame) button to decrease flame height or to set the appliance at pilot flame.
- For fine adjustment tap the  (large flame) or  (small flame) buttons.

Express Low and High Fire



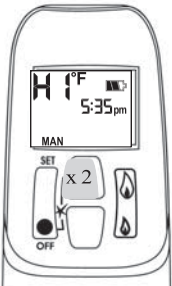

- Double-click  (small flame) button. “LO” will be displayed. NOTE: Flame goes to high fire first before going to designated low fire.



- Double-click  (large flame) button. Flame automatically goes to high fire. “HI” will be displayed.

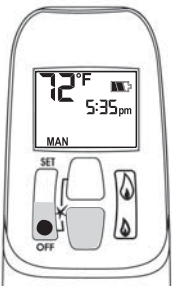

SETTING °C/24-HOUR OR °F/12-HOUR

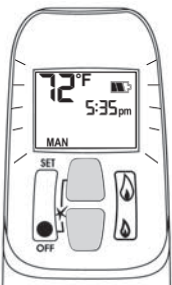

- In MAN mode, press OFF
- and  (small flame) buttons until display changes from Fahrenheit/12-hour clock to Celsius/24-hour clock and vice versa.

SETTING THE TIME



- The time display will flash after either:
 - » Installing the battery or
 - » Simultaneously pressing the  (large flame) and  (small flame) buttons
- Press  (large flame) button to set the hour.



- Press  (small flame) button to set the minute.
- Press OFF or simply wait to return to MAN mode.

MODES OF OPERATION

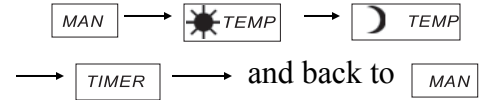

- Briefly pressing the SET button changes the mode of operation in the following order:



NOTE: Manual mode can also be reached by pressing either the  (large flame) or the  (small flame) buttons.



- **MAN** - **Manual Mode** - Manual Flame Height Adjustment.

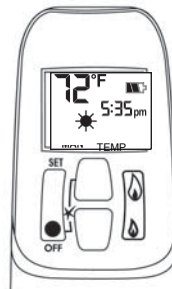

- **TEMP** - **Daytime Temperature Mode** (Appliance must be in standby mode; pilot ignited) - The room temperature is measured and compared to the set temperature. The flame height is then automatically adjusted to achieve the Daytime Set Temperature.

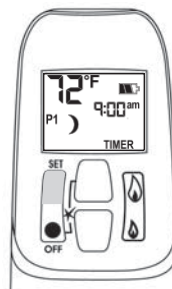

- **TEMP** - **Daytime Temperature Mode** (Appliance must be in standby mode; pilot ignited) - The room temperature is measured and compared to the set temperature. The flame height is then automatically adjusted to achieve the Daytime Set Temperature.

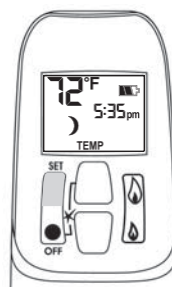

- **TIMER** - **Timer Mode** (Appliance must be in standby mode; pilot ignited) - The timers P1 and P2 (Program 1, Program 2) each can be programmed to go ON and OFF at specific times. For instructions see Timer Programming Mode.

NOTE: The display shows the set temperature every 30 seconds.

MAXITROL GV60 CONTROL SYSTEM

SETTING THE ON / OFF TEMPERATURES

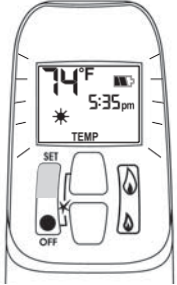

SETTING THE “DAYTIME” TEMPERATURE

Default Settings:  TEMP (sun), 23°C / 74°F



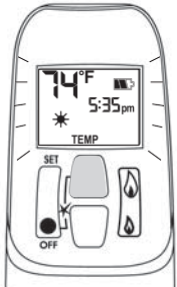

- Briefly press SET button to scroll to TEMP  TEMP (sun) mode. Hold the SET button until the TEMP flashes.

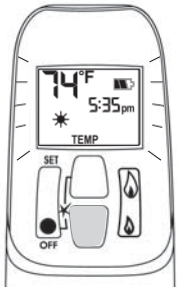

- Press  (large flame) button to increase the  Daytime Set Temperature.



- Press  (small flame) button to decrease  Daytime Set Temperature.

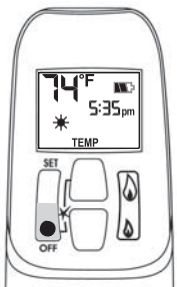

- Press OFF or simply wait to complete programming.

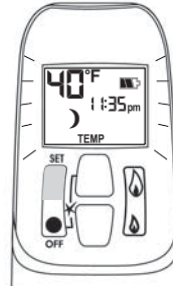

SETTING THE “NIGHTTIME SETBACK” TEMPERATURE

Default Settings:  TEMP (moon), “- -” (OFF)



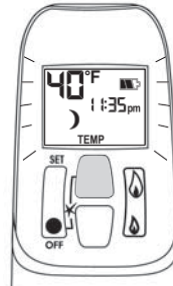

- Briefly press SET button to scroll to TEMP  TEMP (moon) mode. Hold the SET button until the TEMP flashes.

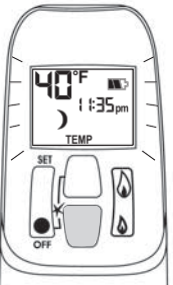

- Press  (large flame) button to increase  Nighttime Setback Temperature.



- Press  (small flame) button to decrease  Nighttime Setback Temperature.

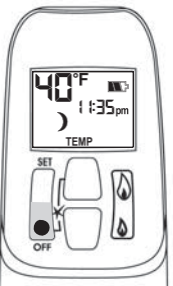

- Press OFF or simply wait to complete programming.

Tip

Set the different parameters when they are flashing.

MAXITROL GV60 CONTROL SYSTEM

SETTING PROGRAM TIMERS

- You can program two periods of time between 12:00 am and 11:50 pm in each 24-hour cycle.
- The Programs P1 and P2 must be set in the following order during a 24-hour cycle: **P1 ☾**, **P1 ☀**, **P2 ☀** and **P2 ☾**.
- The icon ☀ indicates the beginning of the period (ON) and the icon ☾ indicates the end of the period (OFF).
- If **P1 ☀ = P1 ☾**, **P2 ☀ = P2 ☾** the programming is cancelled.
- To keep the fireplace ON all night, set **P2 ☾** at 11:50 am and **P1 ☀** at 12:00 am.

Default settings:

Program 1: **P1 ☀** 6:00 am **P1 ☾** 8:00 am
 Program 2: **P2 ☀** 11:50 pm **P2 ☾** 11:50 pm

- Briefly press SET button to scroll to TIMER mode.

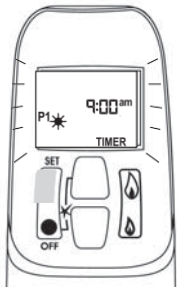
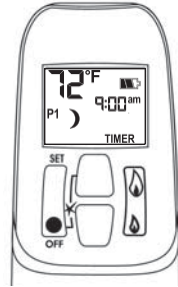

SETTING P1 ON TIME

- Hold the SET button until **P1 ☀** (sun) is displayed and the time flashes.

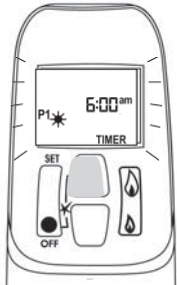

- Press ☹ (large flame) button to set the hour.

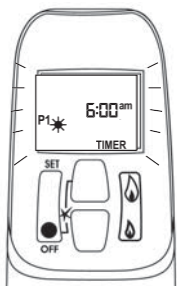

- Press ☺ (small flame) button to set the minutes.

SETTING P1 OFF TIME

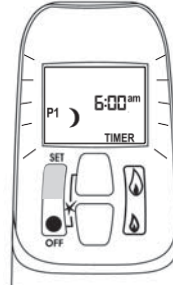

- Briefly press SET button or scroll to TIMER **P1 ☾** (moon) while the time flashes.

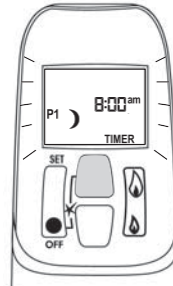

- Press ☹ (large flame) button to set the hour.



- Press ☺ (small flame) button to set the minutes.

SETTING P2 ON TIME

- Briefly press SET to scroll to TIMER mode **P2 ☀** (sun) while the time flashes.
- Follow the instructions given to set P1 ON time.

SETTING P2 OFF TIME

- Briefly press SET to scroll to TIMER mode **P2 ☾** (moon) while the time flashes.
- Follow the instructions given to set P1 OFF time.

Press OFF button to save these settings. The timers are programmed. See the diagram on programming sequences on the following page.

Tip

If you want to program only one period, program **P1 ☀** and **P1 ☾** with desired times and program **P2 ☾** and **P2 ☾** with the same time as **P1 ☾**.

MAXITROL GV60 CONTROL SYSTEM

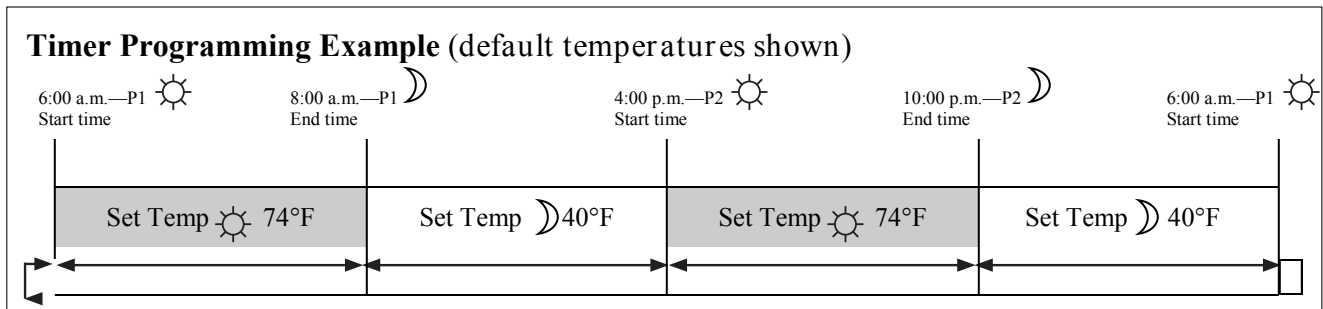

AUTOMATIC TURN DOWN

- **No communication.** If there is no communication between the receiver and the handset for a period of 6 hours, the appliance goes into pilot mode.
- **No change in flame height.** If there is no change in flame height for a period of 6 hours, the appliance goes into pilot mode.

NOTE: In **TEMP** or **TIMER** modes, the flame height will vary according to room temperature. The appliance will continue to work normally. However, if the room temperature remains the same for 6 hours, the appliance will go into pilot mode.

AUTOMATIC SHUT OFF

- **Low batteries in the receiver.** With low battery power in the receiver the system shuts off completely.

NOTE: This does not apply when the power supply is interrupted.

No change in pilot. The appliance shuts off completely when it is continually in pilot position—without any change—for a period of 5 days.

LOW BATTERY INDICATION

CAUTION

DO NOT USE a screwdriver or other metallic object to remove the batteries from the battery box or the handset! This could cause a short circuit.

Remote handset: The battery icon  will show when the battery needs to be replaced. Replace with one 3 “AAA” **alkaline** batteries.

Receiver: Three short ‘beeps’ will sound when the motor turns when the batteries need to be replaced. Replace with four 1.5 V **alkaline** batteries.

HANDSET / RECEIVER MATCH

The remote control handset and receiver are programmed to function together. In case of a replacement of the handset or the receiver, you will need to reset the receiver to allow them to function together. Contact your dealer for details.

MAINTENANCE

A qualified service agency should conduct an annual inspection and maintenance of your **TWENTY6** including the overall installation and venting to keep it running safely. The following procedures should be performed only by a qualified service person. The gas supply should be turned off and the stove should be completely cool whenever a maintenance procedure is performed. All parts of the appliance that are removed for servicing must be replaced prior to operation.

WARNING: Do not operate the appliance with the glass front removed, cracked or broken. Replacement of the glass should be done by a qualified service person.

WARNING: Use only glass assembly, P/N 26-510 which includes the glass panel, frame and gasket. Do not use substitute materials. Do not strike or slam the glass front. The appliance area must be kept clear and free from combustible materials, gasoline and other flammable vapors and liquids.

CAUTION: DO NOT OPERATE WITH BROKEN GLASS

REPLACING THE GLASS

The glass mounting system consists of the glass panel, special glass gasket and the metal glass frame. Should the glass need to be replaced, you must replace the entire glass/glass frame assembly (PN 26-510). See page 46 for information on obtaining replacement parts. Use the following procedure and refer to the illustrations on page 29 of this manual.

1. Turn the fireplace completely off and allow it to cool to room temperature.
2. Remove the fireplace surround. See instructions on page 31.
3. If the glass is broken, be sure to wear gloves and eye protection.
4. Remove the glass frame fasteners from the top edge of the glass frame.
5. This will allow the glass frame to tip slightly forward. The glass may be loose in the frame, so it is very important to support both the glass and the frame when handling. Place your thumbs on the outside of the glass frame and wrap your fingers around the frame and onto the glass. Squeeze the frame and glass while moving. Carefully lift the glass frame and glass up and off the fireplace. Set the glass and frame aside on a padded surface. If the glass is broken, do this over spread out newspaper to catch all loose material. Wrap the old glass frame, glass and gasket in several layers of newspaper and discard.

Installing the replacement glass/glass frame assembly.

1. Unpack the new glass/glass frame assembly taking care when handling.
2. Carefully pick up the glass and glass frame assembly by grasping the sides of the frame and using your thumbs and fingers to hold the glass in place within the gasket and frame.
3. With the glass frame (and glass) at a slight angle (leaving room for your fingers between the frame and the firebox) insert the bottom edge of the frame into the frame retainer located on the bottom front of the firebox. Take care to center the frame from left to right. Once the bottom edge is in place, move your fingers out of the way and press the top of the frame against the firebox while pushing down to be sure the frame is fully engaged in the frame retainer. Hold the frame in place with one hand and reinstall the glass frame fasteners, leaving them loose.
4. Tighten the glass frame fasteners in stages working from the center out. Continue the process until all fasteners are uniformly tight. Do not over-tighten the fasteners.
5. Replace the fireplace surround.. See instructions on page 31.

CLEANING THE GLASS

WARNING: Never clean the glass while it is hot. Do not use abrasive cleaners or cleaners containing

MAINTENANCE

Inspecting the Venting

An inspection of both the inner and outer vent pipes and the vent terminal should be made as part of the annual service appointment. The venting must have no blockage and be in good repair. The vent manufacturer's instructions may provide specific details on vent inspection. Any vent sections that are disassembled must be reassembled and sealed as required. Any safety screen, guard, or barrier removed for servicing an

This appliance should be inspected before use and at least annually by a qualified service person. More frequent cleaning may be required due to excessive dust or lint from carpeting, bedding materials, pets, etc. It is imperative that control compartments and circulating air passageways of this appliance be kept clean.

Cleaning the Burner and Firebox

During the annual inspection and maintenance appointment, the service person should clean the burner and firebox. To gain access to the firebox and burner, follow the instructions beginning on page 34 of this manual.

DO NOT USE A VACUUM CLEANER TO CLEAN THE GLASS BURNER MEDIA.

A vacuum cleaner may be used to clean the metal parts of the firebox. Leave the glass burner media in place. Use a soft brush to clean the burner glass media. If the burner media does need to be removed, carefully scoop it off the burner and avoid dropping glass pieces in the air gaps around the burner. Follow the instructions on page 27 of this manual when replacing the burner media on the burner top.

Air Flow

The **TWENTY6** utilizes a convection air heat exchange system to maximize heat delivered from the fireplace. It is important that air flows freely through the convection air system and out the top and side air grills. Do not place objects under the fireplace that will block the convection air inlet flow or in front of

MAINTENANCE LOG

We strongly recommend that you keep a log of the regular maintenance that is performed on your fireplace. We have provided the forms below to make it easy. Simply ask your qualified service person to fill out one of the maintenance record forms below, each time the fireplace is serviced. This will help insure that all of the required maintenance procedures have been completed, at least annually. Regular maintenance will help keep the fireplace functioning in a safe and reliable manner. Additional forms are available from your installer or service person when needed.

Date of Service _____
Serviced By _____
Service Performed

- Inspect Venting
- Clean Burner & Firebox
- Clean Control Area
- Clean Convection Air System
- Leak Test Gas Connections
- Other _____

Date of Service _____
Serviced By _____
Service Performed

- Inspect Venting
- Clean Burner & Firebox
- Clean Control Area
- Clean Convection Air System
- Leak Test Gas Connections
- Other _____

Date of Service _____
Serviced By _____
Service Performed

- Inspect Venting
- Clean Burner & Firebox
- Clean Control Area
- Clean Convection Air System
- Leak Test Gas Connections
- Other _____

Date of Service _____
Serviced By _____
Service Performed

- Inspect Venting
- Clean Burner & Firebox
- Clean Control Area
- Clean Convection Air System
- Leak Test Gas Connections
- Other _____

Date of Service _____
Serviced By _____
Service Performed

- Inspect Venting
- Clean Burner & Firebox
- Clean Control Area
- Clean Convection Air System
- Leak Test Gas Connections
- Other _____

Date of Service _____
Serviced By _____
Service Performed

- Inspect Venting
- Clean Burner & Firebox
- Clean Control Area
- Clean Convection Air System
- Leak Test Gas Connections
- Other _____

REPLACEMENT PARTS LIST

PART NAME	P/N	PART NAME	P/N
Pilot Head NG/LP	26-501	Burner Orifice (NG)	26N-509
Pilot Thermocouple*	M26-502*	Burner Orifice (LP)	26P-509
Pilot Injector (NG)	26N-503	Burner Glass Media – Clear	26-511
Pilot Injector (LP)	26P-503	Burner Module (NG)	26N-901
Receiver Module (Maxitrol)	M46-504	Burner Module (LP)	26P-901
Wall Switch Panel (optional)	M46-505	Firebox Panel – Rear	26-512
Remote Handset (Maxitrol)	M46-507	Firebox Panel – Left	26-513
Gas Valve (Maxitrol)	M46-515	Firebox Panel – Right	26-514
TC Line Red	M46-701	Thermocouple Interrupter Block	M46-703
TC Line Yellow	M46-702	8-Wire Connecting Cable	M46-704
		Glass Assy (including gasket & frame)	26-510

*This is a quick response thermocouple. Replace it only with SÓLAS Part Number M26-502.

For replacement parts and customer service, contact your TWENTY6 dealer or:

SÓLAS, LLC
 4 Technology Drive, Suite 5
 West Lebanon, NH 03784
 (T) 603-298-5778
 (F) 603-298-9246
 sales@solasfires.com

CONTROL SCHEMATIC

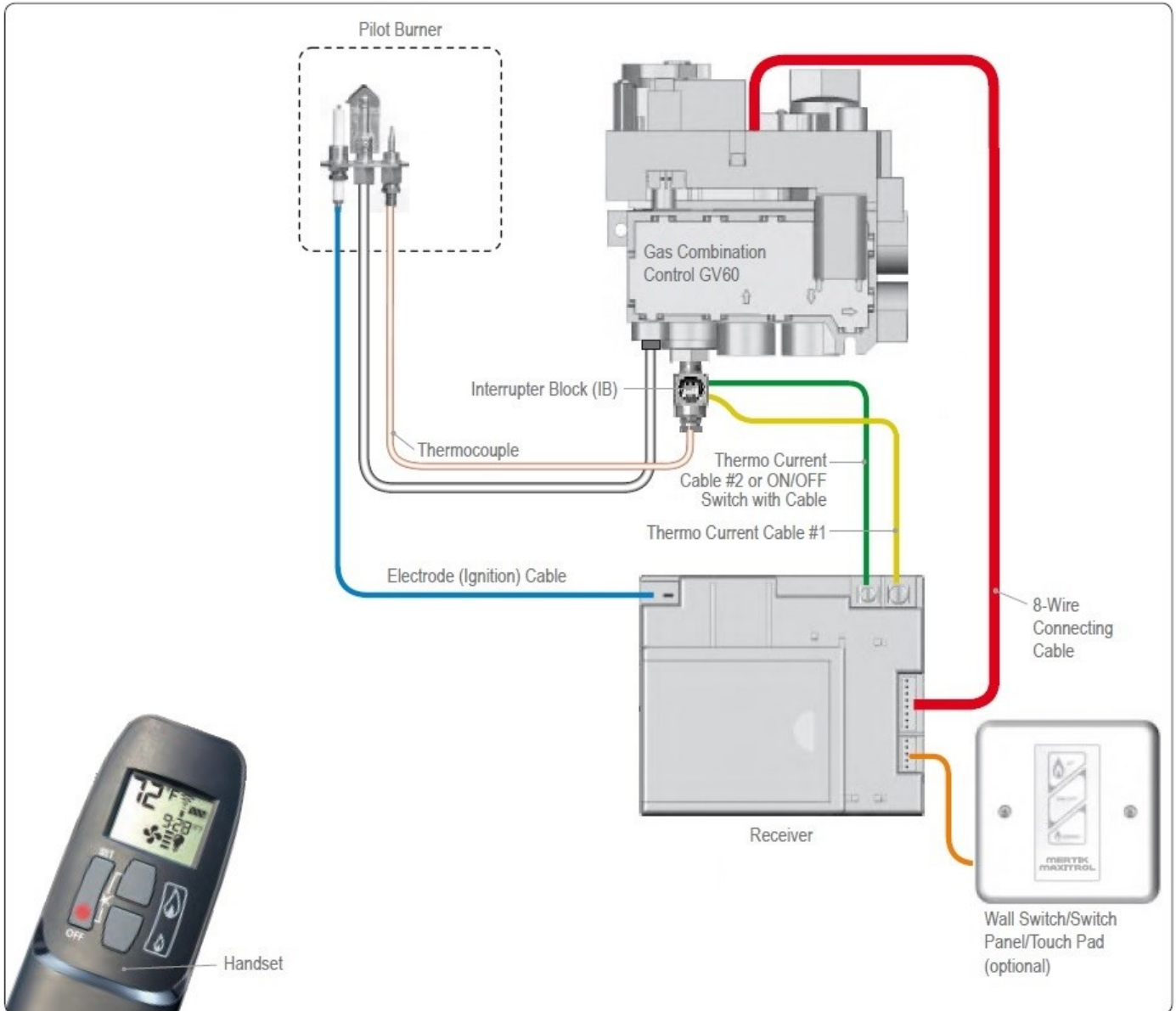

Caution: Label all wires prior to disconnection when servicing the controls. Wiring errors can cause improper and dangerous operation. Verify proper operation after servicing.

INSTALLATION RECORD

The installer should complete the form below that describes the details of the installation. Having this written record of installation information available will greatly expedite trouble-shooting should any problem arise with your stove. The installer should keep a duplicate of this form for their records.

DATE PURCHASED:	<input style="width: 100%;" type="text"/>																										
DEALER:	<input style="width: 100%;" type="text"/>																										
INSTALLER:	<input style="width: 100%;" type="text"/>																										
FIREPLACE S/N:	<input style="width: 100%;" type="text"/>																										
DATE INSTALLED:	<input style="width: 100%;" type="text"/>																										
FUEL:	<input type="checkbox"/> NAT. GAS	<input type="checkbox"/> LP GAS																									
INLET PRESSURE MEASURED AFTER INSTALLATION:	<input style="width: 50px;" type="text"/>	IN. WC																									
MANIFOLD PRESSURE MEASURED AFTER INSTALLATION:																											
	HIGH FIRE:	<input style="width: 50px;" type="text"/>	IN. WC																								
	LOW FIRE:	<input style="width: 50px;" type="text"/>	IN. WC																								
VENTING:																											
<u>VENT BRAND:</u>																											
Simpson DuraVent GS/Pro®	<input type="checkbox"/>	Selkirk Direct-Temp®	<input type="checkbox"/>																								
AmeriVent Direct™	<input type="checkbox"/>	Metal Fab Direct Vent	<input type="checkbox"/>																								
		Security Secure Vent™	<input type="checkbox"/>																								
		ICC EXCELDirect	<input type="checkbox"/>																								
VENT TERMINATION (CAP):	HORIZONTAL <input type="checkbox"/>	VERTICAL <input type="checkbox"/>	SNORKEL <input type="checkbox"/>																								
VENT CAP MODEL NO:	<input style="width: 100%;" type="text"/>																										
<u>CONFIGURATION</u>																											
TOTAL HORIZONTAL RUN:	<input style="width: 100px;" type="text"/>	FEET/INCHES																									
TOTAL VERTICAL RISE:	<input style="width: 100px;" type="text"/>	FEET/INCHES																									
QTY. 90° ELBOWS:	<input style="width: 100px;" type="text"/>																										
QTY. 45° ELBOWS:	<input style="width: 100px;" type="text"/>																										
ALTITUDE:	<input style="width: 100px;" type="text"/>	FEET ABOVE SEA LEVEL																									
WAS STOVE DERATED?	<input style="width: 100px;" type="text"/>	Y or N? IF YES, TO WHAT ORIFICE SIZE? <input style="width: 50px;" type="text"/>																									
UNUSUAL STRUCTURE NEAR VENT TERMINATION - DESCRIBE:	<table border="1" style="width: 100%; border-collapse: collapse;"> <thead> <tr> <th style="width: 33%;">INSIDE CORNER</th> <th style="width: 33%;">TREES/SHRUBS</th> <th style="width: 33%;">OTHER</th> </tr> </thead> <tbody> <tr><td colspan="3" style="height: 20px;"> </td></tr> <tr><td colspan="3" style="height: 20px;"> </td></tr> <tr><td colspan="3" style="height: 20px;"> </td></tr> <tr><td colspan="3" style="height: 20px;"> </td></tr> <tr><td colspan="3" style="height: 20px;"> </td></tr> <tr><td colspan="3" style="height: 20px;"> </td></tr> <tr><td colspan="3" style="height: 20px;"> </td></tr> </tbody> </table>			INSIDE CORNER	TREES/SHRUBS	OTHER																					
INSIDE CORNER	TREES/SHRUBS	OTHER																									
PREVALENT WIND CONDITIONS?																											
OTHER INSTALLATION NOTES:																											



4 Technology Drive, Suite 5
West Lebanon, NH 03784
(T) 603-298-5169
(F) 603-298-9246
sales@solasfires.com

WARRANTY

THE WARRANTY

SOLAS, LLC, a division of Progressive Manufacturing, Inc. ("SOLAS"), Limited Lifetime Warranty warrants your SOLAS brand gas fireplace ("Product") to be free from defects in materials and workmanship at the time of manufacture. The Product body and firebox carry the Limited Lifetime Warranty on workmanship defects causing loss of structural integrity. Ceramic glass carries the Limited Lifetime Warranty against thermal breakage only. After installation, if covered components manufactured by SOLAS are found to be defective in material or workmanship during the Limited Lifetime Warranty period and while the Product remains at the site of the original installation, SOLAS will, at its option, repair or replace the covered components. If repair or replacement is not commercially practical, SOLAS will, at its option, refund the purchase price or wholesale price of the SOLAS product, whichever is applicable. SOLAS will also pay their prevailing labor rates, as determined in its sole discretion, incurred in repairing or replacing such components during the warranty period. THERE ARE EXCLUSIONS AND LIMITATIONS to this Limited Lifetime Warranty as described herein.

COVERAGE COMMENCEMENT DATE

Warranty coverage begins on the date of installation. The warranty shall commence no later than 24 months following the date of product shipment from SOLAS, regardless of the installation date.

EXCLUSIONS AND LIMITATIONS

This Limited Lifetime Warranty applies only if the Product is installed in the United States or Canada and only if operated and maintained in accordance with the printed instructions accompanying the Product and in compliance with all applicable installation and building codes and good trade practices.

This warranty is non-transferable and extends to the original owner only. The Product must be purchased through a listed supplier of SOLAS and proof of purchase must be provided. The Product body and firebox carry the Limited Lifetime Warranty. The following do not carry the Limited Lifetime Warranty, but are warranted as follows:

- Burner** – Repair or replacement for three years from date of installation.
- Gas components & electrical components** – Repair or replacement for one year from date of installation.
- Blowers & remote controls** – Repair or replacement for one year from the date of installation.
- Porcelain Firebox Liners** – Replacement for one year against cracking or breakage due to thermal stress from date of installation. Excludes surface and hairline cracks and scratches or slight color changes that do not affect the operation or safety of the unit.
- Gaskets** – Repair or replacement for one year from the date of installation.
- Surrounds** – Replacement for one year against cracking or breakage due to thermal stress. Excludes surface and hairline cracks and scratches or slight color changes that do not affect the operation or safety of the unit.
- Labor coverage** – Prevailing SOLAS rates apply for the warranty period of the component. SOLAS will not be liable for travel costs for service work.

SOLAS will not be responsible for: (a) damages caused by normal wear and tear, accident, riot, fire, flood, or acts of God; (b) damages caused by abuse, negligence, misuse, or unauthorized alteration or repair of the Product affecting its stability or performance. The Product must be subjected to normal use. The product is designed to burn either natural or propane gas only. Burning conventional fuels such as wood, coal or any other solid fuel will cause damage to the Product, will produce excessive temperatures and could result in a fire hazard. (c) Damages caused by failing to provide proper maintenance and service in accordance with the instructions provided with the Product; (d) damages, repairs or inefficiency resulting from faulty installation or application of the Product.

Discoloration and some minor expansion, contraction, or movement of certain parts and resulting noise is normal and not a defect, and, therefore, not covered under warranty. The installer must ensure the appliance is burning as per the rating tag at the time of installation. Over-firing (operation above the listed BTU rate) of this appliance can cause serious damage and will nullify this warranty.

This warranty is void if:

- The unit has been operated in atmospheres contaminated by chlorine, fluorine or other damaging chemicals.
- The unit is subject to submersion in water or prolonged periods of dampness or condensation.
- Any damage to the unit, combustion chamber, heat exchanger or other components due to water or weather damage which is the result of, but not limited to improper chimney/venting installation.

Damage to stainless steel, gold, nickel or porcelain enameled surfaces caused by fingerprints, scratches, melted items, or other external sources left on these surfaces from the use of cleaners is not covered in this warranty.

SOLAS is not responsible for inadequate fireplace system draft caused by air conditioning and heating systems, mechanical ventilation systems, or general construction conditions which may generate negative pressure in the room in which the appliance is installed. Additionally, SOLAS assumes no responsibility for drafting conditions caused by venting configurations, adjoining trees or buildings, adverse wind conditions or unusual environmental factors and conditions that affect the operation of the unit.

This Limited Lifetime Warranty covers only parts and labor as provided herein. In no case shall SOLAS be responsible for materials, components, or construction, which are not manufactured or supplied by SOLAS or for the labor necessary to install, repair, or remove such materials, components, or construction. Additional utility bills incurred due to any malfunction or defect in equipment are not covered by this warranty. All replacement or repair components will be shipped F.O.B. from the nearest stocking SOLAS facility.

LIMITATION ON LIABILITY

WARRANTY INFORMATION

It is expressly agreed and understood that SOLAS' sole obligation and the purchaser's exclusive remedy under this warranty, under any other warranty, expressed or implied, or in contract, tort or otherwise, shall be limited to replacement, repair, or refund, as specified herein.

In no event shall SOLAS be liable for any incidental or consequential damages caused by defects in the Product, whether such damage occurs or is discovered before or after repair or replacement, and whether such damage is caused by SOLAS' negligence. SOLAS has not made and does not make any representation or warranty of fitness for a particular use or purpose, and there is no implied condition of fitness for a particular purpose.

SOLAS makes no expressed warranties except as stated in this Limited Lifetime Warranty. The duration of any implied warranty is limited to the duration of this expressed warranty.

No one is authorized to change this Limited Lifetime Warranty or to create for SOLAS any other obligation or liability in connection with the Product. Some states and provinces do not allow the exclusion or limitation of incidental or consequential damages, so the above limitations or exclusions may not apply to you. The provisions of this Limited Lifetime Warranty are in addition to and not a modification of or subtraction from any statutory warranties and other rights and remedies provided by law.

INVESTIGATION OF CLAIMS AGAINST WARRANTY

SOLAS reserves the right to investigate any and all claims against this Limited Lifetime Warranty and to decide, in its sole discretion, upon the method of settlement.

To receive the benefits and advantages described in this Limited Lifetime Warranty, the appliance must be installed and repaired by a licensed contractor approved by SOLAS.

Contact SOLAS at the address provided herein to obtain a listing of approved dealers/distributors. **SOLAS shall in no event be responsible for any warranty work done by a contractor that is not approved without first obtaining SOLAS' prior written consent.**

HOW TO REGISTER A CLAIM AGAINST WARRANTY

In order for any claim under this warranty to be valid, you must contact the SOLAS dealer/distributor from which you purchased the product. If you cannot locate the dealer/distributor, then you must notify SOLAS in writing. SOLAS must be notified of the claimed defect in writing within 90 days of the date of failure. Notices should be directed to the SOLAS Warranty Department at 4 Technology Drive, Suite 5, West Lebanon, NH 03784 or visit our website at www.SOLASfires.com.

RECORD YOUR PRODUCT INFORMATION

Model #: _____	Serial #: _____
Date Purchased: _____	Date Installed: _____



Manufactured by:
Progressive Manufacturing Inc.
4 Technology Drive, Suite 5
West Lebanon, NH 03784
USA