

### INSTALLATION & OPERATION MANUAL

MODELS: SL-16N, SL-16P

#### **WARNING**

##### **FIRE OR EXPLOSION HAZARD**

Failure to follow safety warnings exactly could result in serious injury, death, or property damage.

- Do not store or use gasoline or other flammable vapors and liquids in the vicinity of this or any other appliance.
- **WHAT TO DO IF YOU SMELL GAS**
  - Do not try to light any appliance.
  - Do not touch any electrical switch; do not use any phone in your building.
  - Immediately call your gas supplier from a neighbor's phone. Follow the gas supplier's instructions.
  - If you cannot reach your gas supplier, call the fire department.
- Installation and service must be performed by a licensed installer, service agency or the gas supplier.

**DUE TO HIGH TEMPERATURES, THE APPLIANCE SHOULD BE LOCATED OUT OF TRAFFIC AND AWAY FROM FURNITURE AND DRAPERIES.**

**CHILDREN AND ADULTS SHOULD BE ALERTED TO THE HAZARD OF HIGH SURFACE TEMPERATURE AND SHOULD STAY AWAY TO AVOID BURNS OR CLOTHING IGNITION.**

**YOUNG CHILDREN SHOULD BE CAREFULLY SUPERVISED WHEN THEY ARE IN THE SAME ROOM WITH THE APPLIANCE.**

**DO NOT PLACE CLOTHING OR OTHER FLAMMABLE MATERIAL ON OR NEAR THE APPLIANCE.**

**WARNING** Improper installation, adjustment, services or maintenance can cause injury or property damage. Refer to this manual. For assistance or additional information, consult a licensed installer, service agency or the gas supplier.



*Ce manuel est disponible en Francais sur demande.*

This appliance may be installed in an aftermarket, permanently located, manufactured home (USA only) or mobile home, where not prohibited by local codes.

This appliance is only for use with the type of gas indicated on the rating plate. This appliance is not convertible for use with other gases, unless a certified kit is used.



## DANGER



**HOT GLASS**  
WILL CAUSE BURNS.

**DO NOT TOUCH GLASS**  
UNTIL COOLED.

**NEVER ALLOW CHILDREN**  
TO TOUCH GLASS.

A barrier designed to reduce the risk of burns from the hot viewing glass is provided with this appliance and must be installed for the protection of children and other at-risk individuals.

## INSTALLATION RECORD

# SÓLAS

The installer should complete the form below that describes the details of the installation. Having this written record of installation information available will greatly expedite trouble-shooting should any problem arise with your stove. The installer should keep a duplicate of this form for their records.

Date Purchased: \_\_\_\_\_

Dealer: \_\_\_\_\_

Date Installed: \_\_\_\_\_

Installer: \_\_\_\_\_

Fireplace Model: **ONE6**

Serial Number: \_\_\_\_\_

Brand of Venting Used: \_\_\_\_\_

Model # of Vent Cap Used: \_\_\_\_\_

Fuel: (circle one) **Natural Gas (NG)** **Propane (LP)**

Was this field converted? (circle one) YES NO

Inlet Pressure (after installation): \_\_\_\_\_

Manifold Pressure (after Installation): High Fire: \_\_\_\_\_ in. WC

Low Fire: \_\_\_\_\_ in. WC

Altitude: (feet above sea level) \_\_\_\_\_

Was the Fireplace derated? (circle one) YES NO

If the Fireplace was derated, to what orifice size? \_\_\_\_\_

Other installation notes: \_\_\_\_\_

\_\_\_\_\_

\_\_\_\_\_

\_\_\_\_\_

# CONTENTS

---

Installation Record .....	2
Important Safety Information.....	5
Specifications .....	8
Clearances .....	9
Massachusetts Requirements.....	10
Venting.....	11
Assembly & Installation.....	19
Gas Connection .....	32
Lighting & Operation .....	39
Remote Operation.....	41
Gas Conversion .....	49
Maintenance .....	54
Maintenance Log.....	56
Replacement Parts List .....	57
Control Schematic.....	58
Warranty Information .....	59

## ***Congratulations on your purchase of a SÓLAS Fireplace!***

We welcome you to the SÓLAS family of gas fireplaces. Each of our products are skillfully designed and expertly manufactured in the USA. We take great pride in every fireplace we make and each product is fully tested throughout the production process to ensure your safety and warmth throughout the years.

Sincerely,  
The SÓLAS Team

**WE STRONGLY SUGGEST THAT YOU READ THIS MANUAL THOROUGHLY BEFORE BEGINNING THE INSTALLATION OF THIS DIRECT-VENT GAS FIREPLACE. ALTHOUGH THE BASIC REQUIREMENTS FOR THE INSTALLATION OF ALL DIRECT VENT GAS FIREPLACES ARE SIMILAR, EACH SPECIFIC PRODUCT HAS ITS OWN UNIQUE SET-UP AND INSTALLATION REQUIREMENTS THAT MUST BE FOLLOWED EXACTLY. PLAN YOUR INSTALLATION IN ADVANCE BY CAREFULLY REVIEWING ALL THE INFORMATION CONTAINED IN THIS MANUAL.**

The information contained in this manual is believed to be correct at the time of printing. SÓLAS LLC. reserves the right to change or modify any information or specifications without notice. SÓLAS LLC grants no warranty, implied or stated, for the installation or maintenance of your appliance, and assumes no responsibility for any consequential damage(s).

© 2023 Copyright SÓLAS LLC.

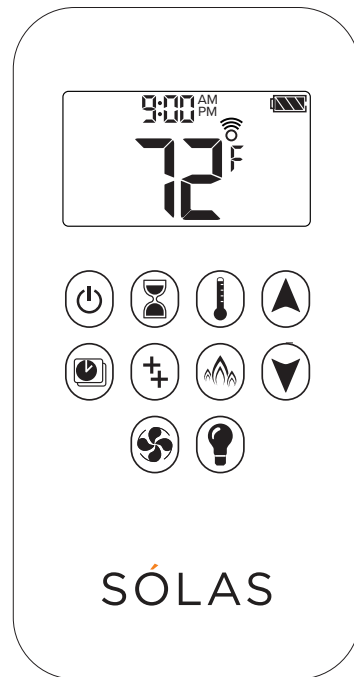

**SÓLAS One-Touch  
Programmable Thermostatic Remote**  
(see page 41)

## ***Félicitations pour votre achat d'un SÓLAS !***

*Nous vous souhaitons la bienvenue dans la famille des foyers au gaz SÓLAS. Chacun de nos produits est habilement conçu et fabriqué de manière experte aux États-Unis.*

*Nous sommes très fiers de chaque foyer que nous fabriquons. Chaque produit est entièrement testé tout au long du processus de production pour garantir votre sécurité et votre chaleur au fil des ans.*

*Sincèrement,*

*SÓLAS*

**AVERTISSEMENT:** Assurez vous de bien suivre les instructions données dans cette notice pour réduire au minimum le risque d'incendie ou d'explosion ou pour éviter tout dommage matériel, toute blessure ou la mort.

Ne pas entreposer ni utiliser d'essence ni d'autres vapeurs ou liquides inflammables dans le voisinage de cet appareil ou de tout autre appareil.

**— QUE FAIRE SI VOUS SENTEZ UNE ODEUR DE GAZ:**

- Ne pas tenter d'allumer d'appareil.
- Ne touchez à aucun interrupteur. Ne pas vous servir des téléphones se trouvant dans le bâtiment où vous trouvez.
- Appelez immédiatement votre fournisseur de gaz depuis un voisin. Suivez les instructions du fournisseur.
- Si vous ne pouvez rejoindre le fournisseur de gaz, appelez le service des incendies.

— L'installation et l'entretien doivent être assurés par un installateur ou un service d'entretien qualifié ou par le fournisseur de gaz.

Cet appareil peut être installé dans une maison préfabriquée (mobile) déjà installée à demeure si les règlements locaux le permettent.

Cet appareil doit être utilisé uniquement avec les types de gaz indiqués sur la plaque signalétique. Cet appareil ne peut être converti à d'autres gaz, sauf si une trousse de conversion est utilisée.

Ne pas utiliser cet appareil s'il a été plongé, même partiellement, dans l'eau. Appeler un technicien qualifié pour inspecter l'appareil et remplacer toute partie du système de commande et toute commande qui a été plongée dans l'eau.

**ATTENTION:** Au moment de l'entretien des commandes, étiquetez tous les fils avant de les débrancher. Des erreurs de câblage peuvent entraîner un fonctionnement inadéquat et dangereux.

S'assurer que l'appareil fonctionne adéquatement une fois l'entretien terminé.

**ATTENTION:** Ne pas utiliser l'appareil si la panneau frontal en verre n'est pas en place, est craqué ou brisé. Confiez le remplacement du panneau à un technicien agréé.

**INSTALLATEUR: LAISSEZ CE MANUEL AVEC L'APPAREIL.  
CONSOMMATEUR: CONSERVEZ CE MANUEL AUX FINS DE CONSULTATION ULTÉRIEURE.**

## IMPORTANT SAFETY INFORMATION

**ATTENTION: THIS FIREPLACE IS DESIGNED AS A WALL-MOUNTED PRODUCT, THIS FIREPLACE IS NOT TO BE “BUILT-IN” TO A WALL OR INSTALLED WITHIN A WALL CAVITY OR ALCOVE. THE INSTALLATION MUST COMPLY WITH THE CLEARANCES NOTED ON PAGE 9.**

The installation must conform with local codes or, in the absence of local codes, with the National Fuel Gas Code, ANSI Z223.1/NFPA 54, or the Natural Gas and Propane Installation Code, CSA B149.1.

A manufactured home (USA only) or mobile home OEM installation must conform with the Manufactured Home Construction and Safety Standard, Title 24 CFR, Part 3280 or when such a standard is not applicable, the Standard for Manufactured Home Installations, ANSI/BCSBCS A225.1, or Standard for Gas Equipped Recreational Vehicles and Mobile Housing, CSA Z240.4.

The appliance and its appliance main gas valve must be disconnected from the gas supply piping system during any pressure testing of that system at test pressures in excess of ½ psi (3.5 kPa).

The appliance must be isolated from the gas supply piping system by closing its equipment shutoff valve during any pressure testing of the gas supply piping system at test pressures equal to or less than ½ psi (3.5 kPa).

The installation must provide for adequate ventilation air to the appliance.

This gas appliance must not be connected to a chimney flue serving a separate solid-fuel burning appliance.

The appliance, when installed, must be electrically grounded in accordance with local codes, or, in the absence of local codes, with the National Electrical Code ANSI/NFPA 70, or the Canadian Electrical Code, CSA C22. 1.

The appliance area must be kept clear and free from combustible materials, gasoline and other flammable vapors and liquids.

The flow of combustion and ventilation air must not be obstructed. Adequate accessibility clearances must be maintained for servicing and proper operation of this appliance.

Do not use this appliance if any part has been under water. Immediately call a licensed service technician to inspect the appliance and to replace any part of the control system and any gas control which has been under water.

**Due to high temperatures, the appliance should be located out of traffic and away from furniture and draperies.**

**Children and adults should be alerted to the hazards of high surface temperatures and should stay away to avoid burns or clothing ignition.**

**Young children should be carefully supervised when they are in the same room as the appliance. Toddlers, young children and others may be susceptible to accidental contact burns. A physical barrier is recommended if there are at-risk individuals in the house. To restrict access to a fireplace or stove, install an adjustable safety gate to keep toddlers, young children and other at-risk individuals out of the room and away from hot surfaces.**

**A barrier designed to reduce the risk of burns from the hot viewing glass is provided with this appliance and shall be installed for the protection of children and other at-risk individuals. If the barrier becomes damaged, the barrier shall be replaced with the manufacturer’s barrier for this appliance.**

**Clothing or other flammable material should not be placed on or near the appliance.**

**Any screen or guard removed for servicing an appliance must be replaced prior to operating the appliance.**

## IMPORTANT SAFETY INFORMATION



Installation and repair should be done by a licensed service technician. The appliance should be inspected before use and at least annually by a professional service technician. More frequent cleaning may be required due to excessive lint from carpeting, bedding material, etc. It is imperative that the control compartments, burners and circulating air passageways of the appliance be kept clean.

**WARNING:** Do not operate the appliance with the glass door assembly removed, or if the glass is cracked or broken. Replacement of the glass should be done by a licensed service technician.

**WARNING:** Use only glass assembly, P/N 16-510, which includes the glass panel, frame and gasket. Do not use substitute materials. Do not strike or slam the glass front. Do not use abrasive cleaners. Do not clean when hot.

**CAUTION:** Do not operate with broken glass.

# CERTIFICATION

This appliance has been certified by PFS TECO to ANSI Z21.88-2016/CSA 2.33-2016 Vented Gas Fireplace Heaters and CAN/CGA-2.17-2017, Gas-Fired Appliances for Use At High Altitudes.

This SÓLAS Gas Fireplace is approved for installation at elevations up to 2000 feet in the U.S. and 1370 meters (4500 feet) in Canada without change. If your installation is at an

elevation greater than these, consult with the local authority having jurisdiction for gas product installations to determine their specific requirements for high altitude installations.

These appliances are approved for installation in the Commonwealth of Massachusetts by the Board of State Examiners of Plumbers and Gas Fitters.

## SÓLAS DIRECT VENT GAS FIREPLACES

MODEL NOS. SL-16N, SL-16P  
VENTED GAS FIREPLACE HEATER  
NOT FOR USE WITH SOLID FUEL.

SER. NO.  
**SL16-**

THIS APPLIANCE IS EQUIPPED FOR:

NATURAL GAS  PROPANE (LP) GAS

	Natural Gas	Propane	
Input Rating-Btu/hr	13,500	13,500	Debit Calorifique
Min. Input Rating-Btu/hr Orifice - DMS	7,500	7,500	Puissance
	#53	#53	Minimum L'injecteur
Manifold Pressure	4.8"wc/1.2kPa	10.0"wc/2.5kPa	Press. A la tubulure
Min. Supply Pressure	5.5"wc/1.4kPa	11.0"wc/2.8kPa	Press. D'Arrivée
Max. Supply Pressure	10.0"wc/2.5kPa	13.0"wc/3.3kPa	Min Press.
			D'Arrivée Max

This product has been tested and listed by PFS TECO to ANSI Z21.88-2016 · CSA 2.33-2016 Vented Gas Fireplace Heaters and CSA 2.17-2017, Gas-Fired Appliances For Use At High Altitudes. This appliance equipped only for alti-tudes from 0-2000 feet (0-610m). In Canada 0-4500 feet (0-1370m).  
This appliance must be installed in accordance with local codes, if any; If none follow the *National Fuel Gas Code, ANSI Z223.1/NFPA 54, of Natural Gas and Propane installation Codes, CSA-B149.1.*

MINIMUM CLEARANCES TO COMBUSTIBLE CONSTRUCTION:

Fireplace Surround to L. Side Wall	6" (152mm)
Fireplace Surround to R. Side Wall	6" (152mm)
Fireplace Surround to Corner Wall	6" (152mm)
Fireplace Surround to Ceiling Wall	8" (203mm)
Fireplace Surround to Rear Wall	0" (0mm)
Fireplace Surround to Floor	3" (76mm)*

\*The minimum required clearance to be maintained from the fireplace to combustible flooring is measured from the top surface of carpeting, tile, etc.

**CAUTION:** Do not operate the appliance with glass doors removed, cracked or broken. Replacement of the glass panel(s) should be done by a licensed or qualified service person. See the Owner's Manual for more information.

WARNING: Improper installation, adjustment, alteration, service or maintenance can cause injury or property damage. Refer to the owner's information manual provided with this appliance. For assistance or additional information, consult a qualified installer, service agency or the gas supplier.

**CAUTION:** Label all wires prior to disconnection when servicing. Wiring errors can cause improper and dangerous operation. Verify proper operation after servicing.

Keep burner and control compartments clean. See installation and operating instructions accompanying appliance.

This vented gas fireplace is not for use with air filters. This appliance is only for use only with the type of gas indicated on the rating plate and may be installed in an aftermarket, permanently located, manufactured home (USA only) or mobile home, where not prohibited by local codes. See Owner's Manual for details.

This appliance is not convertible for use with other gases, unless a certified conversion kit is used.

This appliance must be properly connected to a Direct Vent, venting system in accordance with the manufacturer's installation instructions.

FOR USE WITH GLASS DOORS CERTIFIED WITH THE APPLIANCE ONLY.

**CAUTION:** HOT WHILE IN OPERATION. DO NOT TOUCH, SEVERE BURNS MAY RESULT. KEEP CHILDREN, CLOTHING, FURNITURE, GASOLINE AND OTHER LIQUIDS HAVING FLAMMABLE VAPORS AWAY.



**C** **US**  
Rpt. # F19-217

MANUFACTURED BY:

Progressive Manufacturing Inc.  
452 Sunapee Street  
Newport, NH 03773  
USA

## SÓLAS DIRECT VENT GAS FIREPLACES

MODELE NOS. SL-16N, SL-16P  
Foyer au gaz à évacuation - Ne pas utiliser avec du combustible solide.

CET APPAREIL EST ÉQUIPÉ POUR FONCTIONNER AU:

GAZ NATUREL  PROPANE LIQUÉFIÉ

	Gaz Naturel	Propane	
Debit Calorifique	13,500	13,500	Input Rating-Btu/hr
Puissance Minimum	7,500	7,500	Min. Input Rating-Btu/hr Orifice - DMS
L'injecteur	#53	#53	
Press. A la tubulure	4.8"wc/1.2kPa	10.0"wc/2.5kPa	Manifold Pressure
Press. D'Arrivée Min.	5.5"wc/1.4kPa	11.0"wc/2.8kPa	Min. Supply Pressure
Press. D'Arrivée Max.	10.0"wc/2.5kPa	13.0"wc/3.3kPa	Max. Supply Pressure

Ce produit a été testé et répertorié PFS TECO conformément au ANSI Z21.88-2016 · CSA 2.33-2016 Foyers à gaz ventilés et CSA 2.17-2017, et CSA P.4.1-02. Cet appareil peut être utilisé à des altitudes comprises entre 0 et 610m (0 et 2000 pieds) (E.U. seulement) ou entre 0 et 1370m (0 et 4500 pieds) (Canada seulement) sans modification. Installez l'appareil selon les codes ou règlements, ou dans l'absence de tels règlements, selon les codes d'installation. *ANSI Z223.1 National Fuel Gas Code, ou CSA-B149.1 en vigueur.* Cet appareil doit être correctement raccordé à un système d'évacuation conformément aux instructions du fabricant.

DISTANCES MINIMALES PAR RAPPORT AUX MATÉRIEAUX INFLAMMABLES:

Entourage entre le foyer et le mur à gauche	152mm
Entourage entre le foyer et le mur à droite	152mm
Entourage entre le foyer et le mur d'angle	152mm
Entourage entre le foyer et le plafond	203mm
Le foyer et le mur au fond	0mm
Entourage entre le foyer et le plancher	76mm*

\*On mesure l'espace minimum requis entre le foyer et le sol combustible du surface du tapis, des carreaux, etc.

**ATTENTION:** Ne pas utiliser l'appareil si le panneau frontal en verre n'est pas en-place, est craqué ou brisé. Confiez le remplacement de panneau à un technicien agréé.

AVERTISSEMENT: Une installation, un réglage, une modification, une réparation ou un entretien mal effectué peut causer des dommages matériels ou des blessures. Voir la notice de l'utilisateur qui accompagne l'appareil. Pour de l'aide ou des renseignements supplémentaires, consultez un installateur, un technicien agréé ou le fournisseur de gaz.

**ATTENTION:** Avant de le faire des réparations, marquez tous les fils avant de les débrancher. Les erreurs avec le circuit électronique peuvent causer des fonctionnements dangereux et incorrects.

S'assurer que le brûleur et le compartiment des commandes sont propres. Voir les instructions d'installation et d'utilisation qui accompagnent l'appareil.

Ne pas utiliser de filtre à air avec ce foyer au gaz évacuation.

Cet appareil peut être installé dans une maison préfabriquée (É.U. seulement) ou mobile déjà installée à demeure si les règlements locaux le permettent. Voir la notice de l'utilisateur pour plus de renseignements. Cet appareil doit être utilisé uniquement avec les types de gaz indiqués sur la plaque signalétique. Cet appareil ne peut pas être utilisé avec d'autres gaz sauf si une trousse de conversion certifiée est fournie.

POUR UNE UTILISATION AVEC PORTES EN VERRE CERTIFIÉES AVEC L'APPAREIL UNIQUEMENT.

**ATTENTION:** L'appareil est chaud lorsqu'il fonctionne. Ne pas toucher l'appareil. Risque de brûlures graves surveiller les enfants. Garder les vêtements, les meubles, l'essence ou autres liquides produisant des vapeurs inflammables loin de l'appareil.



**C** **US**  
Rpt. # F19-217

FABRIQUÉ PAR:

Progressive Manufacturing Inc.  
452 Sunapee Street  
Newport, NH 03773  
USA

\*Sample Rating Label (affixed to Control Panel within Firebox)

# SPECIFICATIONS

## ONE6 SPECIFICATION CHART

INPUT	NATURAL GAS	PROPANE
Input Rating	13,500 BTU/Hr.	13,500 BTU/Hr.
Min. Input Rating	7,500 BTU/Hr.	7,500 BTU/Hr.
Orifice-DMS	#53	#58
GAS SUPPLY	NATURAL GAS	PROPANE
Manifold Pressure High	4.8"w.c. / 1.2kPa	10.0"w.c. / 2.5kPa
Manifold Pressure Low	2.2"w.c. / 0.6kPa	3.1"w.c. / 0.8kPa
Min. Supply Pressure	5.5"w.c. / 1.4kPa	11.0"w.c. / 2.8kPa
Max. Supply Pressure	10.0"w.c. / 2.5kPa	13.0"w.c. / 3.3kPa
EFFICIENCY NG / LP	NATURAL GAS	PROPANE
Maximum Observed Steady State Efficiency - %	79.0	77.8
Steady State Efficiency - %	62.6	56.4
Annual Fuel Utilization Efficiency (AFUE) - %	50.9	45.0
Canadian p.4 Efficiency - %	56.2	47.8

**NOTE: The maximum achievable steady state efficiency can vary depending on how the fireplace is installed and operated.**

- It is recommended that the pilot flame be turned off if the appliance will not be in use for an extended period of time.
- This appliance is equipped for use with the fuel type indicated on the rating plate. Field conversion is only permitted with a conversion kit supplied by SÓLAS. See page 49 for gas conversion instructions.

This appliance has been certified by PFS TECO to ANSI Z21.88-2016/CSA 2.33-2016 Vented Gas Fireplace Heaters and CSA-2.17-2017, Gas-Fired Appliances for Use At High Altitudes and CSA P.4.1-09. The is approved for installation at elevations up to 2000 feet in the U.S. and 1370 meters (4500 feet) in Canada without change. If your installation is at an elevation greater than these, consult with the local authority having jurisdiction for gas product installations to determine their specific requirements for high altitude installations.

## ONE6 OVERALL DIMENSIONS

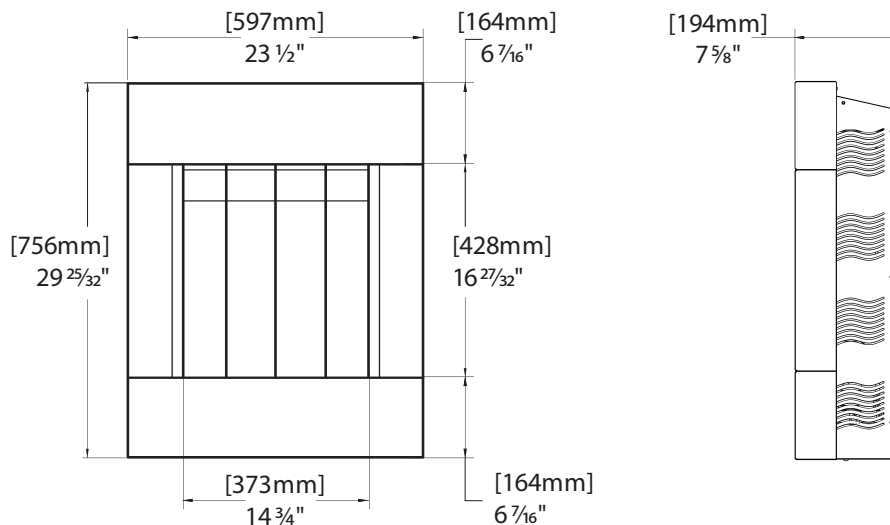



# CLEARANCES

Several issues must be addressed when selecting a suitable location for your **ONE6** fireplace. The minimum clearances to combustible construction are listed below. In addition, access to the gas supply must be considered. The location of the fireplace will also affect the venting requirements and you must be certain the location will allow compliance with the venting requirements shown on page 11. You must also insure that your installation provides adequate accessibility clearance for servicing and proper operation.

Installation and repair should be done by a licensed service technician. The appliance should be inspected before use and at least annually by a professional service technician. More frequent cleaning may be required due to excessive lint from carpeting, bedding material, etc. It is imperative that the control compartment, burners and circulating air passageways of the appliance be kept clean.

**NOTE: Alcove installation is not permissible.**

## MINIMUM CLEARANCES TO COMBUSTIBLE CONSTRUCTION

Fireplace Surround to L. Side Wall	6" (152mm)
Fireplace Surround to R. Side Wall	6" (152mm)
Fireplace Surround to Corner Wall	6" (152mm)
Vent Pipe to Adjacent Materials	1.5" (38mm)
Fireplace Surround to Ceiling	8" (203mm)
Fireplace Surround to Rear Wall	0" (0mm)*
Fireplace Surround to Floor	3" (76mm)**

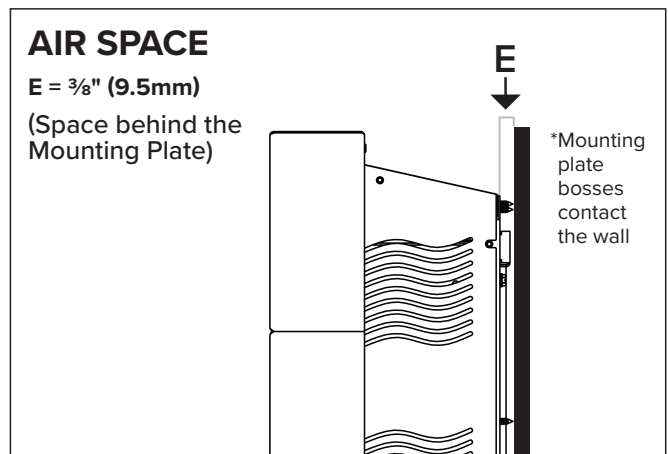
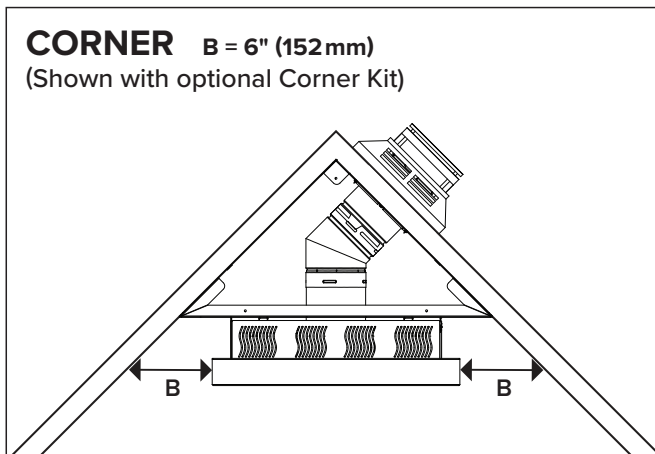
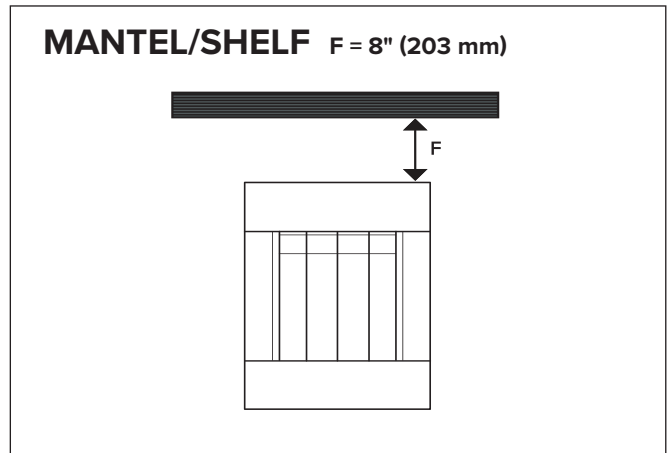
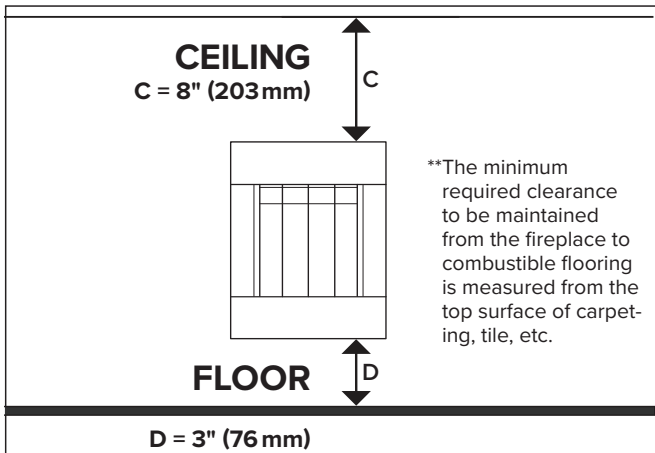
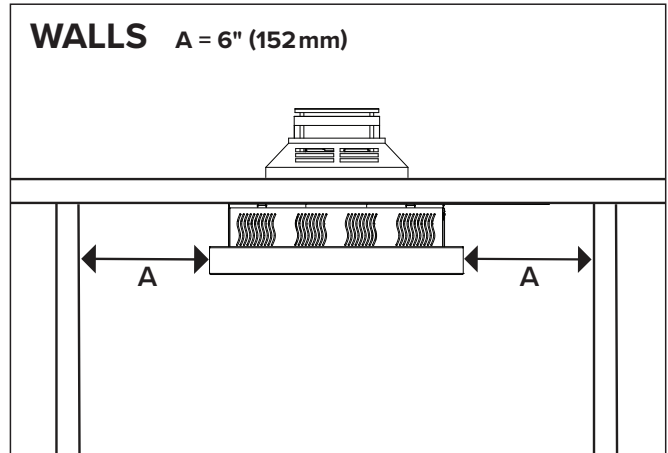

# INSTALLATION REQUIREMENTS

## STATE OF MASSACHUSETTS

The installation must be completed by a licensed plumber or gas fitter in the Commonwealth of Massachusetts.

### REQUIREMENTS FOR THE COMMONWEALTH OF MASSACHUSETTS

This product must be installed by a licensed plumber or gas fitter when installed within the Commonwealth of Massachusetts. If this appliance is installed in a dwelling, building or structure used in whole or in part for residential purposes and the installation includes a horizontal vent termination that is less than seven (7) feet above the finished grade in the area of the venting, including but not limited to decks and porches, a hard-wired carbon monoxide detector with an alarm and battery back-up must be installed on the floor level of the dwelling, building or structure where the appliance is to be installed.

Additionally, a hard-wired or battery operated carbon monoxide detector with an alarm must be installed on each additional level of the dwelling, building or structure served by the appliance. It shall be the responsibility of the property owner to secure the services of licensed licensed professionals for the installation of hard-wired carbon monoxide detectors.

In the event that the horizontally vented appliance is installed in a crawl space or attic, the hardwired carbon monoxide detector with alarm and battery back-up may be installed on the next adjacent floor level.

In the event that this requirement cannot be met at the time of completion of the installation of the appliance, the owner shall have a period of thirty (30) days to comply with the requirement. However, during said thirty (30) day period, a battery operated carbon monoxide detector with alarm must be installed.

Each carbon monoxide detector as required in accordance with the above provisions must comply with NFPA 720 and be ANSI/UL 2034 and IAS certified.

In addition, when the vent termination is less than seven (7) feet above finished grade a metal or plastic identification plate must be permanently mounted to the exterior of the building at a minimum height of eight (8) feet above grade directly in line with the exhaust vent terminal. The sign shall read, in print size no less than one-half (½) inch in size, "GAS VENT DIRECTLY BELOW. KEEP CLEAR OF ALL OBSTRUCTIONS".

The gas fireplace is shipped with a ¾" tube OD (male flare) connection. The gas supply piping should have a separate gas shutoff valve and a ⅛" NPT plugged tapping upstream of the valve. The stove and its main control valve must be disconnected from the gas supply piping system during any pressure testing of that system at test pressures in excess of ½ psi (3.5 kPa). The stove must be isolated from the gas supply piping system by closing the main control valve during any pressure testing of the gas supply system at test pressures equal to or greater than ½ psi (3.5 kPa). After the gas supply has been connected, use a commercial gas leak detector or apply a soapy water solution to all the fittings to check for gas leaks. Never use a flame to test for leaks.

**A COPY OF THESE INSTRUCTIONS PLUS ALL VENTING INSTRUCTIONS WHICH INCLUDE PARTS LISTS, AND/OR ALL VENTING DESIGN INSTRUCTIONS MUST REMAIN WITH THE STOVE AT THE COMPLETION OF THE INSTALLATION.**

**ATTENTION INSTALLERS:** Mark below which venting system was used in the installation. These instructions must remain with the SÓLAS Gas Fireplace Installation & Operation Manual.

- Simpson DuraVent GS/PRO®
- Selkirk Direct-Temp®
- Security Secure Vent™
- AmeriVent Direct™
- Metal Fab Direct Vent
- ICC Direct Vent

#### NOTICE

**Failure to follow these instructions will void the warranty.**

## VENTING

The **SÓLAS ONE6** Direct-Vent Gas Fireplace has been tested and listed for installation with 4" X 6 5/8" Simpson DuraVent GS/Pro®, Selkirk Direct-Temp®, Security Secure Vent™, AmeriVent Direct™, Metal Fab DirectVent and ICC EXCELDirect venting components. Although you may use the pipe components (straight pipe, elbows, etc.) from any of the listed manufacturers, you may only use the vent terminations (caps) listed in the chart on page 12. For installations where a snorkel is needed, please note that only three snorkels are approved for use. Please plan your installation accordingly.

**For all specific venting installation requirements, follow the installation instructions included by the venting manufacturer with the venting system components you have chosen.**

### **Please Note:**

- For venting configurations that include no vertical rise, a total horizontal equivalent vent run of up to 30 inches is allowed (when using a 45° elbow, 18 inches horizontal equivalent must be included). However, if your installation has room to add a vertical pipe section, we suggest adding at least one foot of vertical rise to the system.
  - For venting configurations that include vertical rise, it is assumed that the installation will include at least one 90° elbow. Up to three additional 90° elbows (or equivalent 45° elbows) may also be used. The total venting may not exceed 20 feet of vertical rise and/or 10 feet horizontal run. Refer to the venting charts starting on pages 13 & 14 for specific details while you plan your installation.  
**Note: The number of elbows impacts the maximum allowable horizontal vent run.**
  - Many installations will involve venting directly through standard 2 X 4 or 2 X 6 construction exterior wall to a horizontal vent termination (cap). The vent starter pipe has been designed to accommodate those two common installations without the use of any additional venting components other than a standard horizontal cap. See the chart on page 12 for a list of approved vent caps.
  - A special corner installation kit (Part Number CK-16-1) is also available that will allow the ONE6 fireplace to be mounted in a corner without constructing a 45° partition wall. This kit is available from your SÓLAS dealer and has its own installation instructions. Please refer to those instructions for specific details regarding the installation using the kit.
- If the fireplace will be installed on an interior wall or other location that precludes venting directly through an outside wall to a horizontal vent cap, or if the distance to the outside wall exceeds 30", one or more elbows will be required to allow addition of the required vertical venting to the installation. When vertical venting is required, the fireplace venting may be terminated with either a vertical or horizontal vent cap depending on the specifics of the installation. Refer to the venting charts starting on pages 13 & 14 for specific venting requirements and see the chart on page 12 for a list of approved vent caps before you plan your installation.
  - There should be at least 1½" overlap of the vent and combustion air tubes, when telescopic joints are used.
  - A minimum clear space of 1½" must be maintained around the vent pipe where it penetrates the first combustible wall adjacent to the fireplace (either the outside wall for the direct-through-the-wall installation or the partition wall for the 45° or other interior wall installations). The special vent pipe heat shields that are provided with the ONE6 must also be installed in the first wall adjacent to the fireplace. A minimum clear space of 1½" must also be maintained where the vent pipe penetrates any other interior wall, exterior wall, ceiling or roof.
  - The ONE6 may also be installed in front of an existing fireplace opening utilizing special co-linear venting components available from the venting manufacturers. These systems split and then recombine the co-axial air and exhaust and allow the use of flexible venting. This makes it easier to run the venting through the narrow fireplace damper opening to the top of the chimney. Refer to the vent manufacturers' instructions. Use the vertical venting column (0 feet Horizontal Run) in the venting charts to determine the required restrictor settings depending on the height of chimney.

## VENTING

The location of the vent termination must meet the requirements of the current edition of ANSI Z223.1/NFPA 54, National Fuel Gas Code or CAN B419.1, Natural Gas and Propane Installation Code and the requirements shown on page 18 of this manual.

APPROVED VENT TERMINATIONS	M&G DURAVENT GS/PRO	SELKIRK DIRECT- TEMP	SECURITY SECURE VENT	AMERIVENT DIRECT VENT	METAL FAB DIRECT VENT	ICC EXCEL DIRECT
<b>VERTICAL CAP</b>	46DVAVCH	1604802	SV4CGC	4DVC	4DVT	TM4VT
<b>HORIZONTAL CAP</b>	46DVAHC 46DVAHRCS 46DVAHSC	1604804	SV4GHC	4DHC	4DHT	TM4HT TM4DHT
<b>SNORKEL</b>	N/A	1604836	N/A	4D36C	N/A	TMST36

Just as with any other vented device, vertical vent rise creates draft (negative pressure) in the firebox as the exhaust gases heat up. If this draft becomes excessive, it can affect the performance or appearance of the fire. The ONE6 fireplace includes air and exhaust restrictors that are used to balance the draft in the fireplace to the optimal level for installations where excessive draft might occur. The venting charts on pages 13 and 14 provide an easy means for determining whether your specific installation requires inlet air or exhaust restrictors or both. To make the determination about whether air or exhaust restrictors are needed, a venting chart worksheet is provided on page 15. Follow the instructions and fill in the worksheet for your particular installation. This will allow you to determine the recommended restrictor settings for your exact installation. Although this might appear to be a complicated process at first glance, it is really quite straight-forward and the result will be a fire that looks and performs as intended. Several examples of worksheet calculations are shown on page 16 to help guide you.

**Please be sure to note that:**

1. There are separate venting charts for Natural Gas and LP Gas. Refer to the appropriate chart for your fuel type to determine your specific restrictor requirements. The settings in the charts have been determined based on extensive testing.
2. Determine the total vertical vent rise and total horizontal vent run for your installation. All measurements are made from the center of the vent opening in the back of the fireplace.
3. If your fireplace will not be venting directly through an outside wall to a horizontal termination or if more than 30" of horizontal vent run is required, some vertical vent rise will be required for the fireplace to function and vent properly. Elbows will also be required for those installations. However, installations are limited to a maximum of four 90° elbows (or 45° elbow equivalents).
4. **Note: Two 45° elbows equal one 90° elbow.**

5. The recommended restrictor settings in the venting charts allow up to two 90° elbows (or 45° elbow equivalents) to be used without affecting the restrictor settings. Additional elbows will require that you calculate a new equivalent horizontal run for your installation to account for the additional flow resistance caused by the extra elbows. For the purposes of calculating the equivalent horizontal vent run, each additional 90° elbow is equivalent to three feet of horizontal vent run and each additional 45° elbow is equivalent to 1.5 feet of horizontal vent run. The total horizontal vent run including elbow equivalents can not exceed 10 feet.
6. The maximum vertical vent rise can not exceed 20 feet.
7. There are two exhaust restrictors that are provided with your fireplace. They are labeled "A" and "B". The A restrictor provides less exhaust restriction than B.
8. An air restrictor plate is also provided with your fireplace. It is a ring with bendable tabs that can be set to adjust the amount of restriction in the air supply system. Once the appropriate number tabs are bent open (in accordance with the requirements for your installation), the plate is inserted between the fireplace and the vent starter pipe.

**SÓLAS Self-Calibrating Power Vent Option**  
**Available for all SÓLAS Wall-Mount DV Models**  
 Learn more @ [solasfires.com](http://solasfires.com)

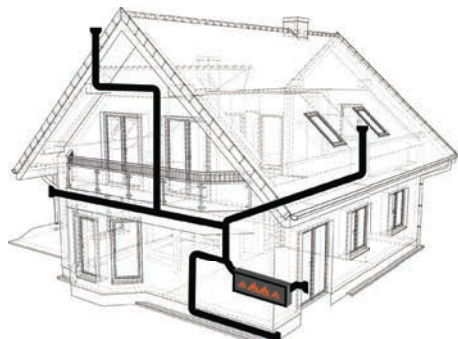





# VENTING CHART WORKSHEET

## VENTING WORKSHEET FOR INSTALLER

Use this worksheet to determine the equivalent horizontal run for use with the vent charts on pages 13 and 14.

The information contained within this worksheet may also be useful during installation or in the event that you need technical assistance from SÓLAS.

**NOTE:** Calculations for horizontal or vertical sections of pipe are measured between transition joints as shown in the image below.

Vent runs that are not 90° vertical are considered to have horizontal run but not a vertical rise.

**NOTE:** Snorkel terminations are counted as (2) 90° elbows.

A. **TOTAL VERTICAL VENT RISE:** Measured as total vertical distance between flanges of elbows used in vent system. (See Diagram) \_\_\_\_\_ Feet

B. **TOTAL HORIZONTAL VENT RUN:** Measured as total horizontal distance between flanges of elbows used in vent system. (See Diagram) \_\_\_\_\_ Feet

C. **TOTAL NUMBER OF 90° ELBOWS in excess of 1:** \_\_\_\_\_ = "C"

**NOTE:** Snorkel terminations are counted as (2) 90° elbows

D. **TOTAL NUMBER OF 45° ELBOWS in excess of 1:** \_\_\_\_\_ = "D"

E. **90° Elbow Horizontal Equivalent:**  $C \times 3 =$  \_\_\_\_\_

F. **45° Elbows Horizontal Equivalent:**  $D \times 1.5 =$  \_\_\_\_\_

G. **Total Horizontal Equivalent:**  $B + E + F =$  \_\_\_\_\_



**NOTE:** Prior to enclosing the wall cavity, test fire the fireplace to ensure it is fully operational.

## VENTING EXAMPLES

### EXAMPLE 1 – ONE6

- A. Total Vertical Vent Rise: 1 feet
- B. Total Horizontal Vent Run: 5 feet
- C. Total Number of 90° Elbows in excess of 1: 1  
*(Snorkel terminations are counted as (2) 90° elbows)*
- D. Total Number of 45° Elbows in excess of 1: 0
- E. 90° Elbow Horizontal Equivalent:  $C \times 3 =$  3
- F. 45° Elbow Horizontal Equivalent:  $D \times 1.5 =$  0
- G. Total Horizontal Equivalent:  $B + E + F =$  8

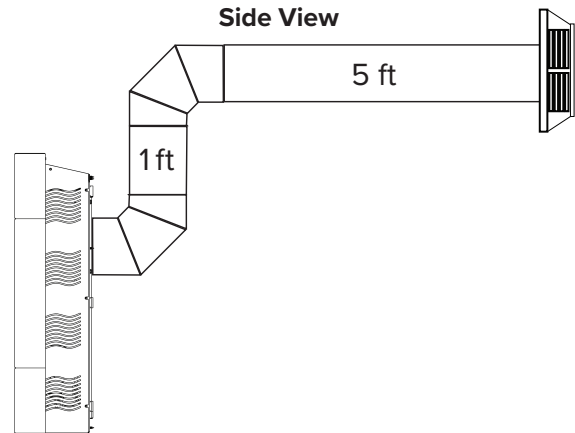

### EXAMPLE 2 – ONE6

- A. Total Vertical Vent Rise: 0 feet
- B. Total Horizontal Vent Run: 2 feet
- C. Total Number of 90° Elbows in excess of 1: 0  
*(Snorkel terminations are counted as (2) 90° elbows)*
- D. Total Number of 45° Elbows in excess of 1: 0
- E. 90° Elbow Horizontal Equivalent:  $C \times 3 =$  0
- F. 45° Elbow Horizontal Equivalent:  $D \times 1.5 =$  0
- G. Total Horizontal Equivalent:  $B + E + F =$  2

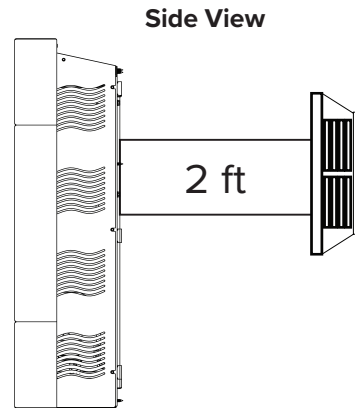

### EXAMPLE 3 –

- A. Total Vertical Vent Rise: 0 feet
- B. Total Horizontal Vent Run: 4 feet
- C. Total Number of 90° Elbows in excess of 1: 1  
*(Snorkel terminations are counted as (2) 90° elbows)*
- D. Total Number of 45° Elbows in excess of 1: 0
- E. 90° Elbow Horizontal Equivalent:  $C \times 3 =$  3
- F. 45° Elbow Horizontal Equivalent:  $D \times 1.5 =$  0
- G. Total Horizontal Equivalent:  $B + E + F =$  7

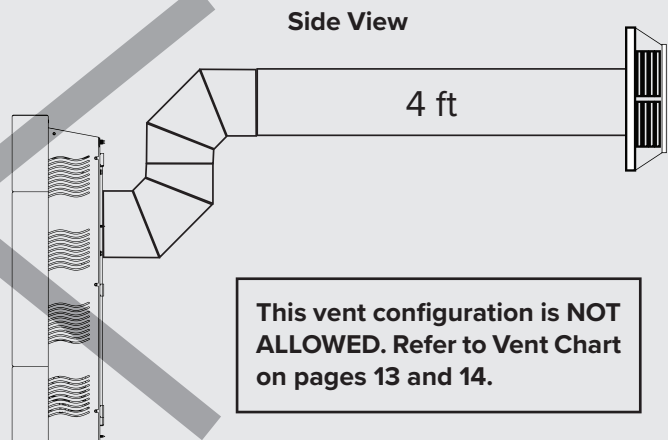

**This vent configuration is NOT ALLOWED. Refer to Vent Chart on pages 13 and 14.**



# VENTING

The illustration below shows some of the many ways the ONE6 fireplace may be installed in the home. This includes interior and exterior wall installations, corner installations and horizontal and vertical vent terminations.

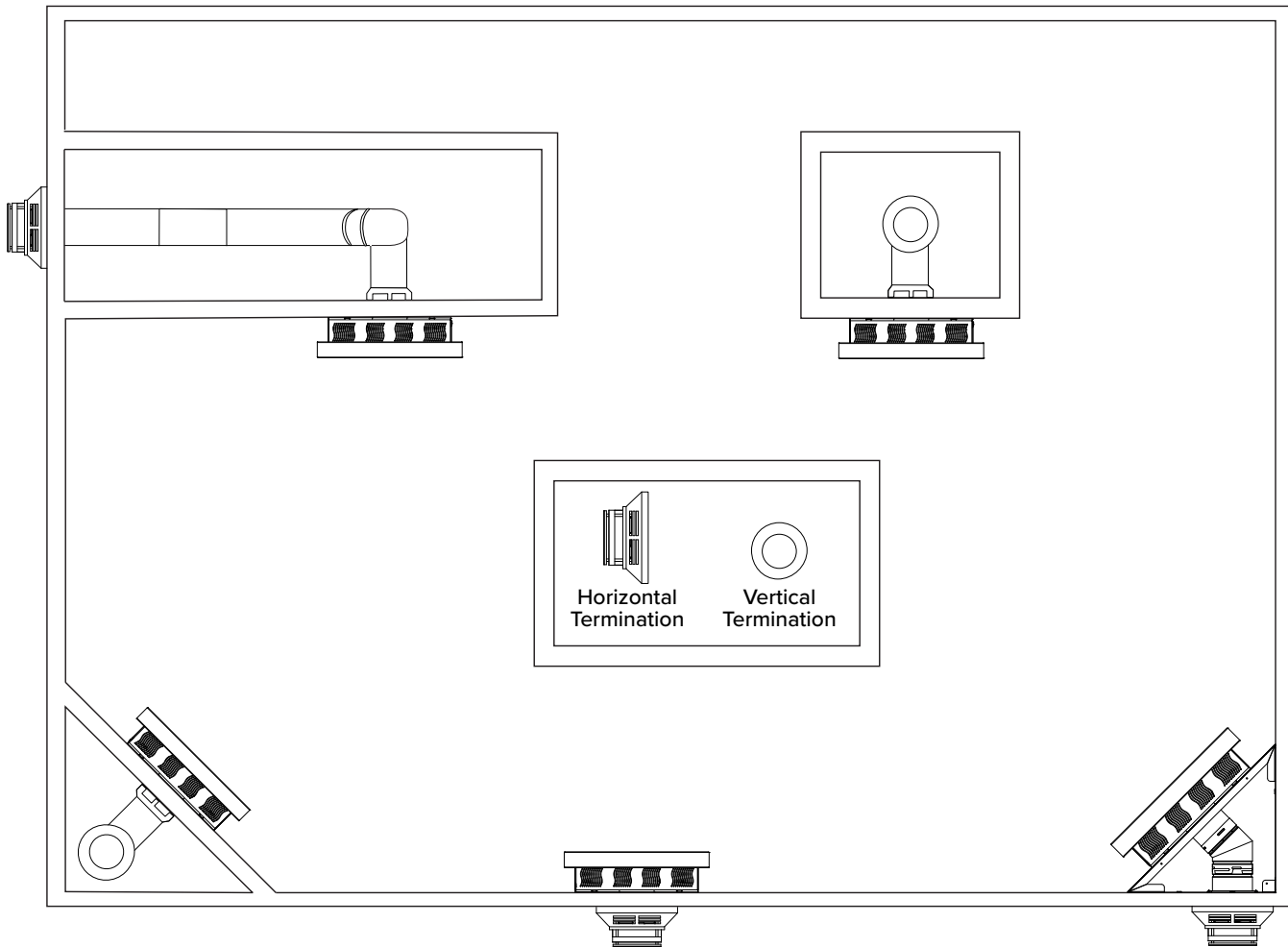

## ONE6 Corner Kit Option

The optional ONE6 corner kit is a great space saver. Corner Installation Kit CK-16-1

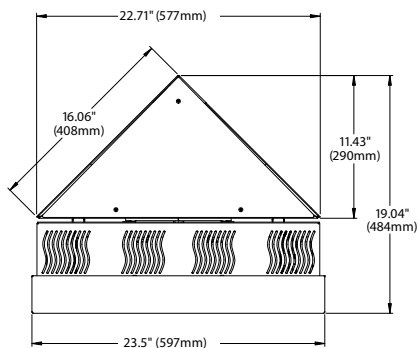

Power vent runs of up to 130ft with (8) 90° elbows are permitted when using the SOLAS Self-Calibrating Power Vent Kit. Refer to power vent instructions for additional power vent installation and operation information.

# VENTING

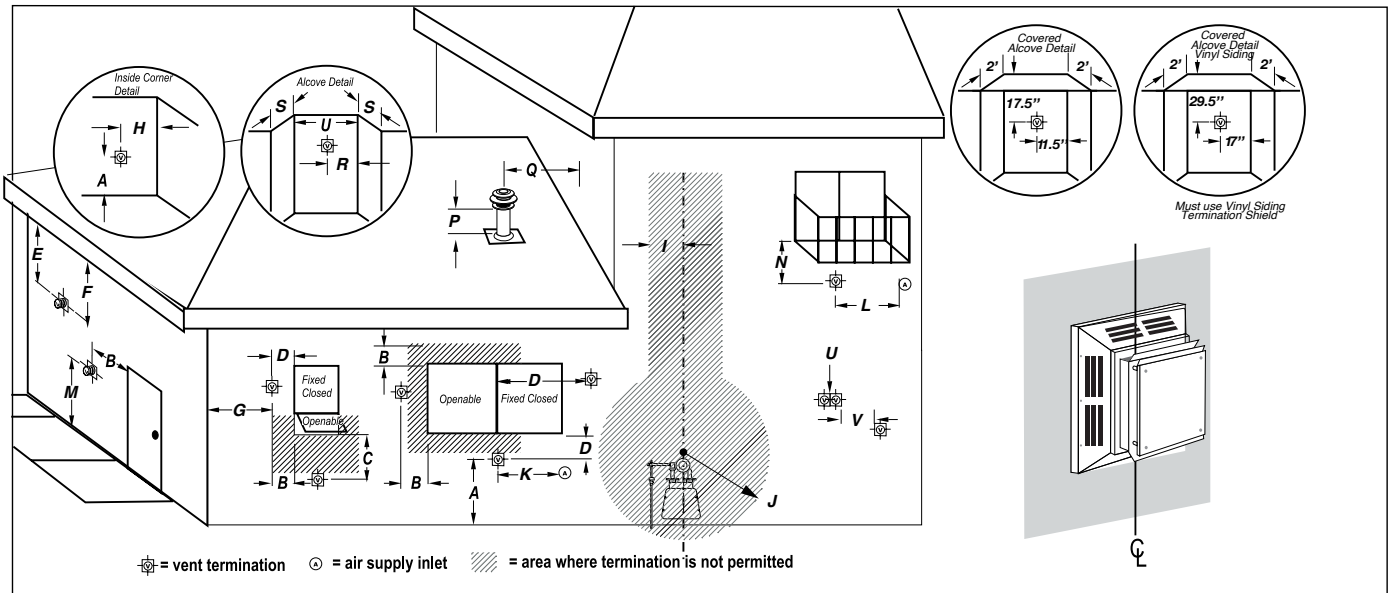

VENT TERMINAL LOCATIONS	CANADA*	U.S.A.**
A = Clearance to the termination frame above grade, veranda, porch, deck, or balcony	12" (30 cm)	12" (30 cm)
B = Clearance to top of doors or operable windows	12" (30 cm)	12" (30 cm)
C = Clearance to sides or bottom of door or operable windows	12" (30 cm)	9" (23 cm)
D = Clearance to permanently closed window, recommended to prevent condensation	16" (41 cm)	16" (41 cm)
E = Clearance to ventilated soffit located within a horizontal distance to 24" (61 cm) from centerline of termination	22" (56 cm)	22" (56 cm)
F = Clearance to unventilated soffit	30" (76 cm) to combustibles 16" (41 cm) to non-combustible	30" (76 cm) to combustibles 16" (41 cm) to non-combustible
G = Clearance to outside corner	9" (23 cm)	9" (23 cm)
H = Clearance to inside corner	12" (30 cm)	12" (30 cm)
I = Clearance to each side of the vertical centerline of a meter or regulatory assembly to a maximum vertical distance of 15ft (4.5m)	36" (91 cm)	36" (91 cm)
J = Clearance to service regulator vent outlet	36" (91 cm)	36" (91 cm)
K = Clearance to non-mechanical air supply inlet to the building or combustion air inlet to other appliance for appliance <=100,000 BTU/H (30 KW)	12" (30 cm)	12" (30 cm)
L = Clearance to forced air supply inlet	72" (183 cm)	36" (91 cm) above air inlet
M = Clearance above paved sidewalk or paved driveway located on public property	84" (213 cm)	84" (213 cm)
N = Clearance under veranda, porch, deck, or balcony	22" to combustibles 16" to non-combustibles	22" to combustibles 16" to non-combustibles
P = Clearance above roof	24" (61 cm)	24" (61 cm)
Q = Clearance to adjacent walls and neighboring buildings	24" (61 cm)	18" (46 cm)
R = Clearance from corner in recessed location	12" (30 cm)	12" (30 cm)
S = Maximum depth of recessed location	48" (122 cm)	48" (122 cm)
T = Maximum width for back wall of recessed location	24" (61 cm)	24" (61 cm)
U = Horizontal clearance between two terminations that are level	0	0
V = Horizontal clearance (center to center) between two terminations that are not level	18" (46 cm)	18" (46 cm)

**Note 1:** For N a vent shall not terminate directly above the sidewalk or paved driveway which is located between two single-family dwellings and serve both dwellings.

**Note 2:** For P only permitted if veranda, porch, deck, or balcony is fully open on a minimum of two sides beneath the floor.

**Note 3:** For J, K, and as specified in CGA B149 installation code. Local codes or regulations may vary.

\* Based on CGA B149.1 Natural Gas and Propane installation code. Local codes may vary, please check with local regulatory agency.

\*\* Based on ANSI Z223.1/NFPA 54 National Fuel Gas Code. Local codes may vary, please check with local regulatory agency.

**NOTICE:** Venting terminations shall not be recessed into a wall or siding.

## ASSEMBLY & INSTALLATION

### UNPACKING THE ONE6 WALL MOUNT FIREPLACE

The fireplace components are shipped in three cartons. By now, you will have opened the top of the first carton, removed the glass protector and this manual. The second carton contains the fireplace surround. The third carton contains the vent starter pipe, vent heat shields and air and exhaust restrictors.

1. Using the adjacent images as a guide, first lift and remove Box 1 from the carton containing the firebox. Carefully unpack the contents of the tube and set aside. This should include the bag of glass burner media, the remote control handset, a hardware bag and relief door with gasket.
2. Next lift and remove Box 2 from the carton. Carefully remove the contents of the tube. This includes the Top & Bottom and Side Panels that will be attached to the fireplace during assembly.
3. Next, remove all remaining packaging materials from the carton.
4. Lift the firebox and the fireplace mounting plate as a unit up and out of the carton. The best place to lift is at sides. Remove the fireplace mounting template from the face of the fireplace. You should now have all of the parts as shown in the image below.
5. Next, unpack the vent starter pipe (with attached gasket), vent cap insulation, the inner and outer pass-thru vent heat shields and the air and exhaust restrictors from the second carton and set aside for later use.
6. Finally, unpack the fireplace surround from the third carton and set aside on a soft surface for later use.

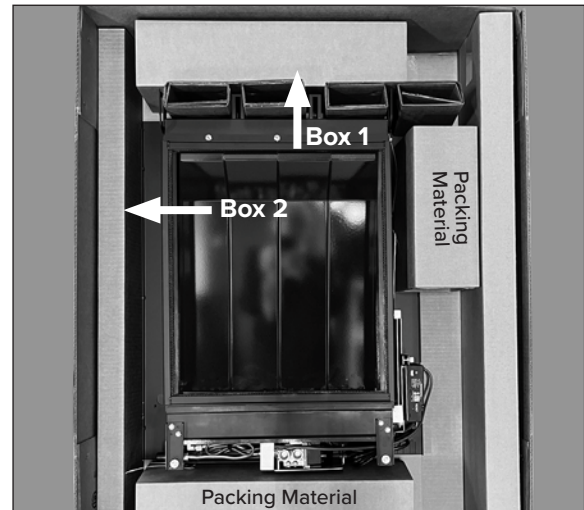

## ASSEMBLY & INSTALLATION



**Before you begin the fireplace mounting process there are several important installation requirements that must be met. Careful planning will make the installation easier to accomplish and will reduce the chances of encountering problems after you start.**

**Note: It is important to locate electrical wiring, plumbing, etc. in the wall before beginning the installation process. An electrician or plumber should be consulted if there is any question about wiring or plumbing locations. Failure to locate and protect wiring or plumbing during the installation process may result in electrical shock, gas leak, fire, and/or explosion which could cause property loss and/or death.**

1. The fireplace is designed to be wall-mounted using 4 lag bolts to secure the fireplace mounting plate to the wall structure. The mounts are located 16" on center and 24" on center to correspond with standard building construction. If your home has non-standard construction or the location you have chosen for the fireplace does not have wall studs that correspond to location of the fireplace mounts, modifications to the wall structure will be needed. It is critical that the 4 lag bolts that are provided for mounting the fireplace are firmly embedded into the wall structure at all four locations.
2. A hole must be provided in the wall for the vent to pass through. The hole must be large enough to provide 1 ½" clearance around the outside of the vent pipe and to allow for installation of the vent heat shields that are provided with the fireplace. Follow the hole size requirements that are provided below exactly to avoid problems. If the location you have chosen does not allow for 1 ½" clearance to wooden framing in the wall, modifications to the wall structure must be made to obtain the needed vent pipe clearance. Refer to the Wall-Mount template on next page.
3. All required minimum clearances to adjacent combustible materials (including side walls, ceiling and floor) must be achieved with the position you have chosen. See the clearance information on page 9. The listed clearances are measured from the outermost front edges of the fireplace surround and not from the fireplace body or mounting plate. In addition the requirements for clearance to combustible materials inside the house, there are specific requirements and limitations that must be met for the location of the vent terminal relative to doors, windows, corners, eaves, gas supply components and other structural elements of the house. Please see page 18 for those specific requirements. Again, plan the installation in advance to avoid problems.
4. The gas supply line must be located within a specific area behind the fireplace. Please see page 32.

# ASSEMBLY & INSTALLATION

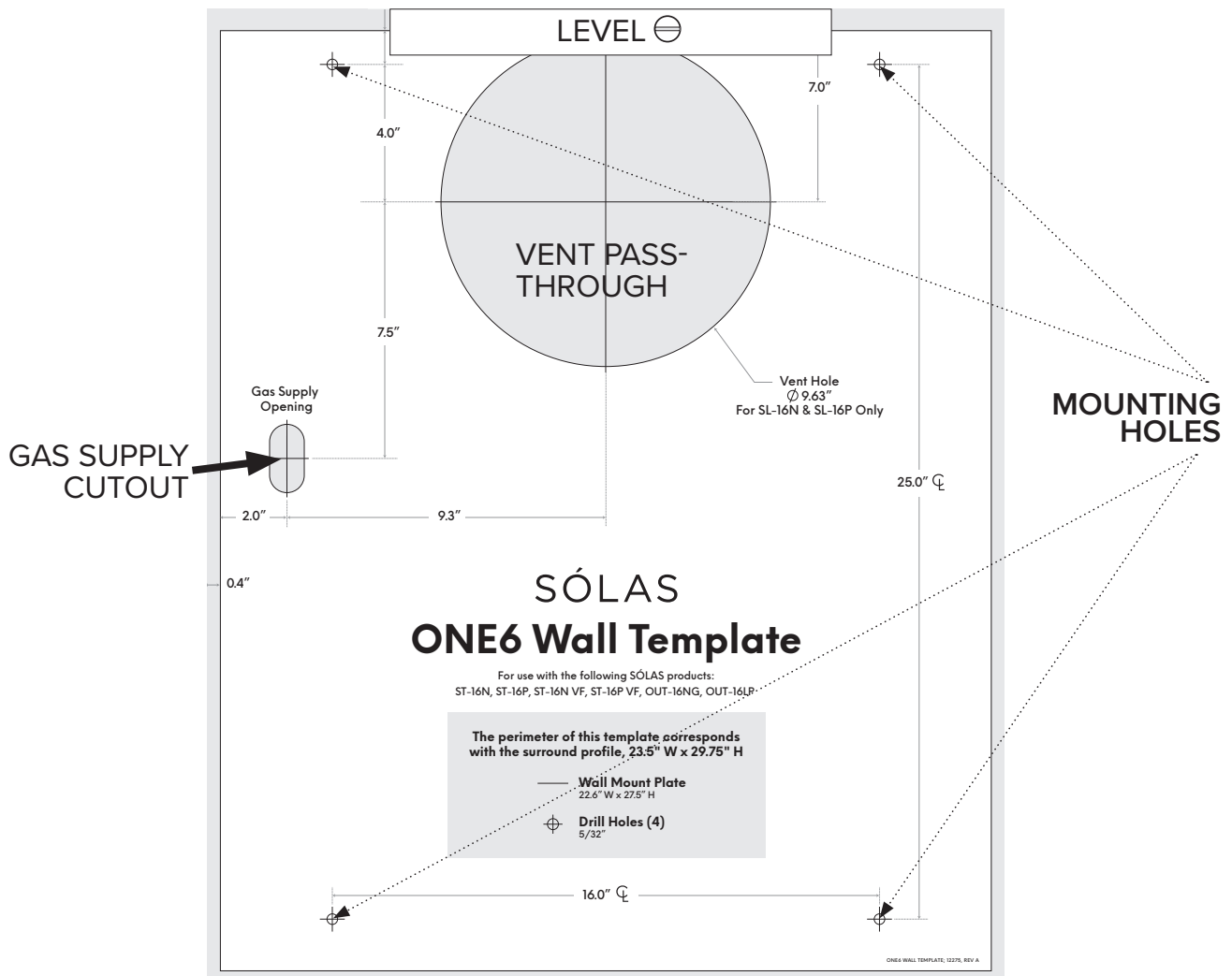

Once you are certain that the location you have chosen meets all the necessary mounting and safety requirements, you can begin the installation.

1. Tape or pin the installation template to the wall in the position where the fireplace is to be mounted. Note: It is important that the fireplace is mounted in a level position. Use a level placed on the cross-hairs in the upper mounting holes or the top line on the template and adjust the template position until the mounting holes are level. Refer to the above illustration.

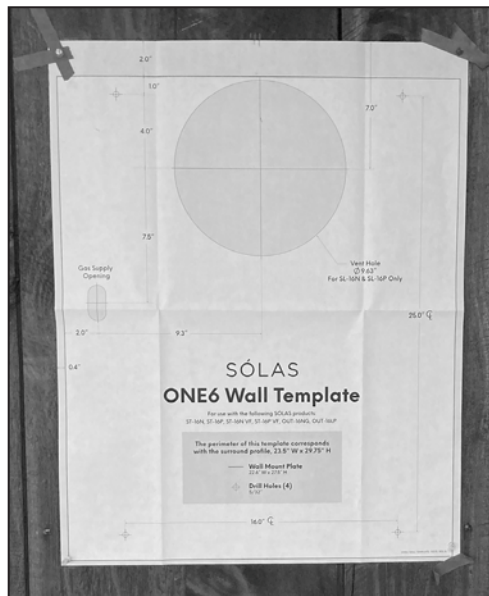

## ASSEMBLY & INSTALLATION

2. Next, carefully transfer the location of the two upper and two lower mounting holes that you will use for your installation. Use a sharp nail, awl or pin to pierce the template on the mounting hole cross-hairs to insure an accurate transfer to your wall.

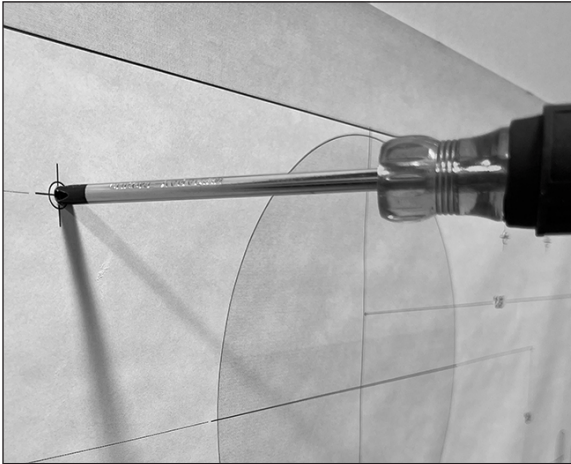

**Note:** It is imperative to note the location of any plumbing or electrical wiring in the wall before beginning the installation process. Consult a plumber or an electrician if there is any doubt about the location of utilities.

3. Next transfer the location for the center of the vent pass-through hole on the wall. Also transfer other points on the diameter of the vent pass-through circle. This will make it easier to cut the circle later.

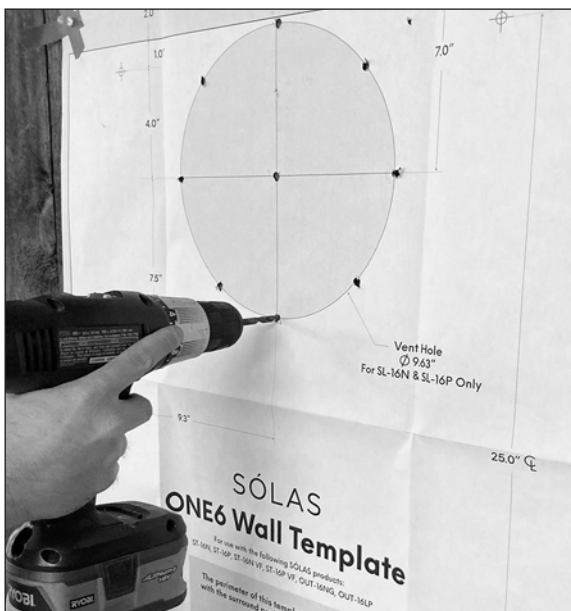

4. Finally, transfer the location of the gas supply line.

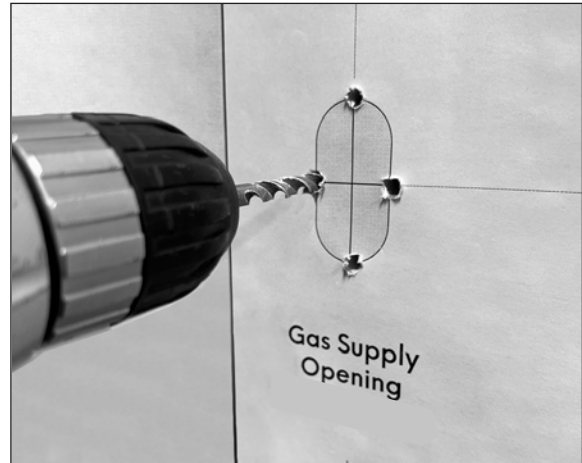

## ASSEMBLY & INSTALLATION

### Vent Pass-Through (Parallel Wall Installation on an Outside Wall)

1. An unobstructed wall pass-through is required to allow for a safe installation of the fireplace vent components. This will necessitate removal of a portion of the interior wall covering (e.g., sheetrock or plaster and lath), outer wall sheathing and outer wall covering and any adjacent internal wall materials (like insulation).
2. Use a long pilot drill ( $\frac{1}{8}$ " diameter) that is held square and level to the inside wall to transfer the vent pass-through center location from the inner wall covering through to the outer wall sheathing and outer wall covering.

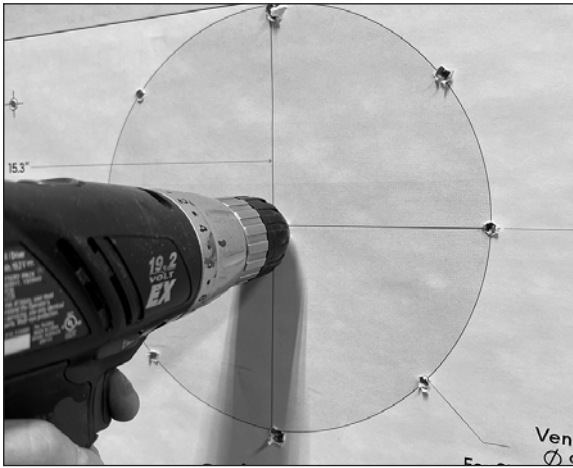

3. Carefully cut the inner wall covering along the template line and remove the circular wall piece.

**Note:** It is imperative to note the location of any plumbing or electrical wiring in the wall before beginning the installation process. Consult a plumber or an electrician if there is any doubt about the location of utilities.

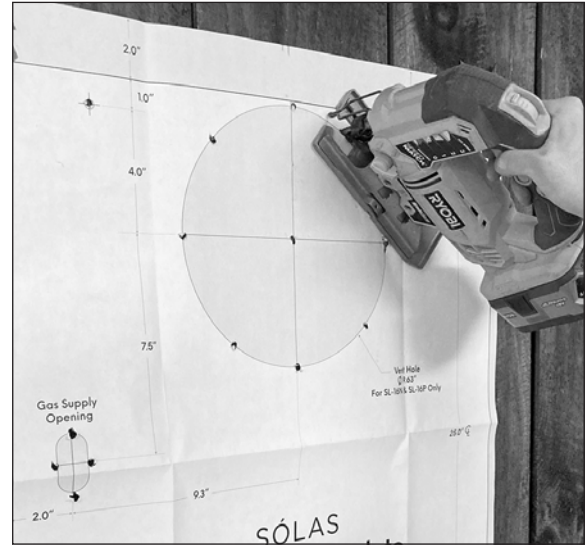

4. Carefully cut the gas supply opening, identified on the template.



5. Remove any insulation materials from wall in the area defined by the pass-through hole.

## ASSEMBLY & INSTALLATION

- Building codes in your area may require that you add blocking above and below the vent opening. The blocking should be above and below the 9 5/8" vent opening you made in the wall and should not obstruct that opening. The blocking should extend to adjacent wall studs.
- Next, mark and cut a 9 5/8" diameter hole through the outer wall covering and sheathing using the locating hole you drilled in Step 2.



- Follow the instructions included with the vent termination (cap) to remove the appropriate amount of outer wall covering (siding) or to install the vinyl siding shield if used. Do not install the chimney cap at this point.

### Vent Pass-Through (Parallel Wall Installation on an Interior Partition Wall)

- An unobstructed wall pass-through is required to allow for a safe installation of the fireplace vent components. This will necessitate removal of a portion of the interior wall covering (e.g., sheetrock or plaster and lath), on both sides of the partition wall and any adjacent internal wall materials (like insulation).
- Scribe a 9 5/8" diameter hole around the vent pass-through center mark using a compass.
- Use a long drill (1/8" diameter) that is held square and level to the inside wall to transfer the vent pass-through center location from the inner wall covering through to the wall covering on the back side of the partition wall.
- Carefully cut the inner wall covering along the scribed line and remove the circular wall piece.  
**Note: It is important to locate electrical wiring in the wall before beginning the installation process. An electrician should be consulted if there is any question about wiring locations. Failure to locate and protect wiring during the installation process may result in electrical shock or fire.**
- Remove any insulation materials from wall in the area defined by the pass-through hole.
- Building codes in your area may require that you add blocking above and below the vent opening. The blocking should be above and below the 9 5/8" vent opening you made in the wall and should not obstruct that opening. The blocking should extend to adjacent wall studs.
- Next, mark and cut a 9 5/8" diameter hole through the wall covering on the back side of the partition wall using the locating hole you drilled in Step 2.
- When installing the fireplace on a partition wall, the venting may be penetrating one or more interior walls, an exterior wall, the ceiling or the roof.
- It is important to lay out the locations of all vent pass-throughs before you begin the installation to insure that the venting will line-up correctly and that the walls and ceiling meet the needed clearances to the vent pipe.
- The vent pass-through in the partition wall where the fireplace is mounted must be done in accordance with the instructions for a parallel wall installation on an outside wall, following steps 1 through 6.

### Vent Pipe (Pass-Through) Heat Shields

Special telescoping double heat shields for the vent pipe are provided with the **ONE6** fireplace. These heat shields are a critical part of a safe installation. They are designed to protect combustible materials in the wall immediately behind the fireplace. The only exception to this is if the corner installation kit (Part Number CK-16-1) is used. With the corner kit, the heat shields are installed where the venting passes through the first adjacent side wall. See the instructions included with the corner kit for specific details.



## ASSEMBLY & INSTALLATION

### Installing the Fireplace Mounting Plate on the Wall

1. The fireplace mounting plate is attached to the wall structure using four ¼" X 1 ½" long lag bolts and large diameter washers that are provided with the fireplace. It is important to use the included hardware as the full weight of the fireplace is supported by the mounting plate.
2. Drill a 5/32" diameter pilot hole at each of the mounting hole locations that you marked using the template. The pilot holes should be the full depth of the lag bolts. Be sure that there is solid wood at each mounting location. If not, the wall should be reconstructed to provide the needed support.

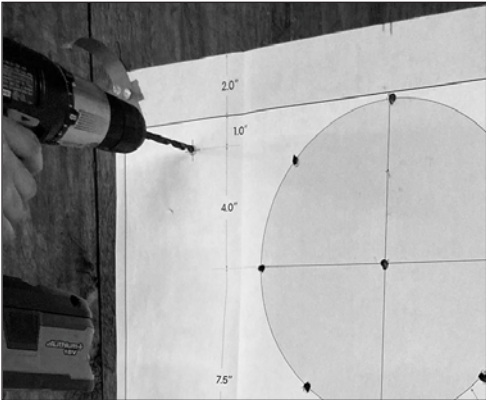

3. Before the mounting plate can be lagged to the wall the two tabbed sections of the telescoping vent pipe heat shields that you set aside earlier must be attached to the mounting plate. Each heat shield half is held in place with three sheet metal screws (provided). The inner shield half (smaller diameter) is installed from the front of the mounting plate. Slide the inner heat shield half through the vent pipe opening in the mounting plate. Align the three tabs with the pilot holes in the mounting plate (as shown in the adjacent photo) and install the three screws.

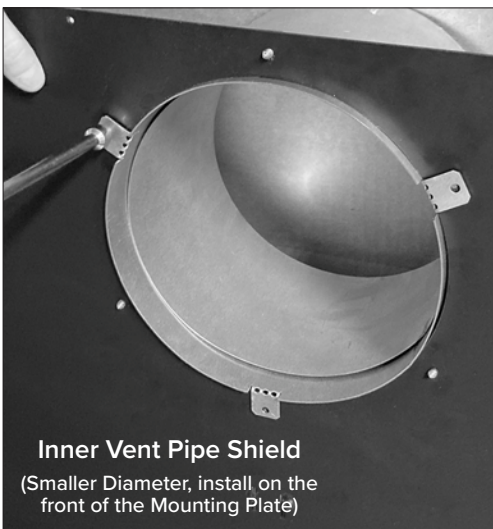

4. The outer vent pipe heat shield half (larger diameter) is installed on the rear of the mounting plate. Slip the outer shield half over the inner shield and align and install the three screws. See photo below.



5. The fireplace mounting plate is now ready to be lagged to the wall structure.
6. With a helper pick up and align the mounting plate over the gas supply line and line up with the four mounting lag bolt pilot holes. These holes are recessed.



## ASSEMBLY & INSTALLATION

### Installing the Fireplace Mounting Plate on the Wall (con't)

**NOTE: It may be helpful to put a light coating of dish or hand soap on the lag bolts to reduce resistance when tightening.**

- Using the lag bolts and washers provided with the fireplace, install the top lag bolts (with washers) first, followed by the lower ones. Use a  $\frac{7}{16}$ " socket wrench to tighten the lag bolts.



When installing the second top lag bolt, ensure the mounting plate is level.

- At this point, check to be sure that there is a  $\frac{3}{8}$ " air gap between the entire flat back surface of the mounting plate and the wall surface. The gap is critical to a safe installation and if the gap is obstructed in any way, remove the obstruction before proceeding.
- Next check that the brackets on the mounting plate that hold the fireplace are level, again using a level. If the brackets are not perfectly level, you can adjust the right bracket by loosening the bracket fasteners and moving the bracket until it is level with the left bracket. Remember to tighten the bracket fasteners once you have achieved a level position.



- The next step is to install the vent starter pipe onto the fireplace.
- Remove the glass panel and glass frame assembly from the front of the firebox by loosening and removing the three  $\frac{7}{16}$ " bolts that are located along the top edge of the glass frame.



- While holding the glass panel and glass frame along the outer edges, tip the top of the glass frame forward a few inches.



- Wrap your fingers around the frame and hold the glass and frame together while you lift the frame up and out of the lower glass retainer. Set the glass and frame assembly aside in a safe place.

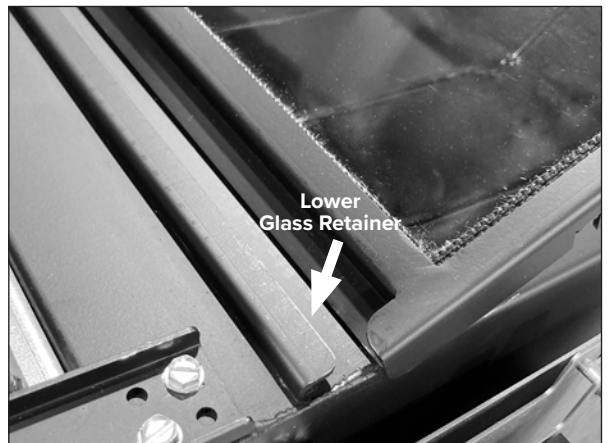

## ASSEMBLY & INSTALLATION

### Installing the Fireplace

- Carefully place the fireplace with the front down on a protected floor.
- At this point, it is necessary to determine whether your installation will require the addition of flow restrictors to the combustion air inlet system or the exhaust outlet or both. Refer to the venting section that starts on page 12 to make that determination.
- If your installation does not require any restrictors, place the vent starter pipe gasket on the back of the fireplace aligning the holes in the gasket with the pilot holes on the rear of the fireplace.

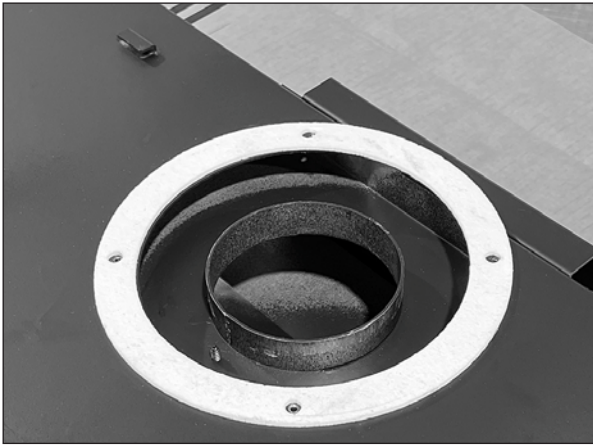

- Align the inner pipe of the vent starter pipe with the exhaust outlet pipe on the fireplace. The vent pipe will fit tightly over the fireplace pipe. Gently push the starter pipe on to the fireplace pipe until the outer pipe flange makes contact with the starter pipe gasket. Be sure that the holes in the starter pipe flange align with the gasket and pilot holes.



- When the flange contacts the gasket, install the (4) #10, 5/16" fasteners provided with the starter pipe.



Skip to step #25 on page 29 if your installation **DOES NOT** require Air Restrictor or Exhaust Restrictor. (NOTE: Restrictors for use in vertical venting installations only).

- If your installation does require an air restrictor or exhaust restrictor or both, (NOTE: Restrictors for use in vertical venting installations only) these must be installed before you install the vent starter pipe. Again, refer to the venting information starting on page 11 to determine the specific restrictor requirements for your specific installation.

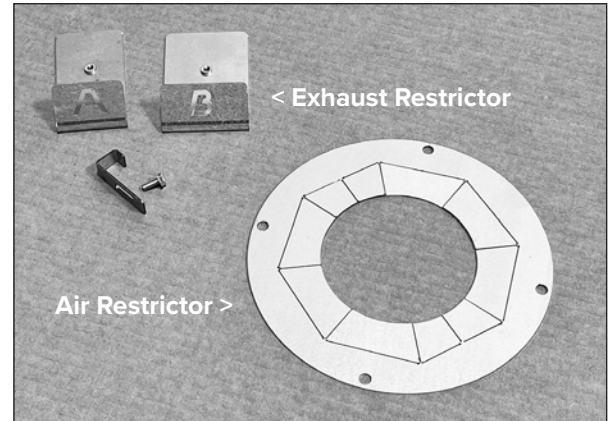

## ASSEMBLY & INSTALLATION

### Installing the Fireplace (con't)

20. Place the vent starter pipe gasket on the back of the fireplace aligning the holes in the gasket with the pilot holes on the rear of the fireplace.

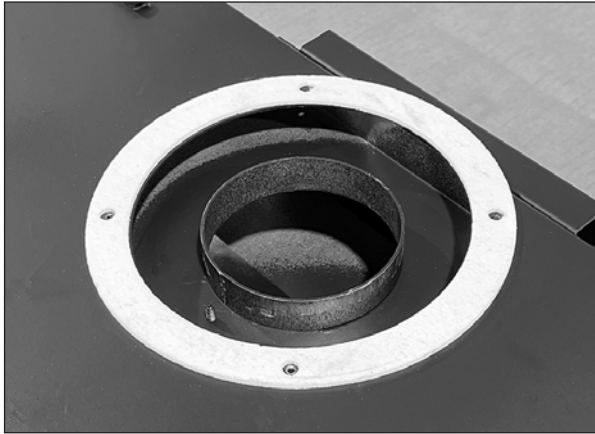

21. The exhaust restrictor is installed by placing it through the exhaust outlet pipe and resting it on the internal baffle in the firebox. It is held in place with a movable retainer clip. Simply hold the restrictor down against the baffle and push the retainer up and tighten screw to secure the restrictor. **Note: Please take care to insure that the exhaust restrictor is centered in the exhaust outlet. Improper alignment could adversely affect the appearance of the flames. Refer to the adjacent images for placement of the exhaust restrictor and clip.**

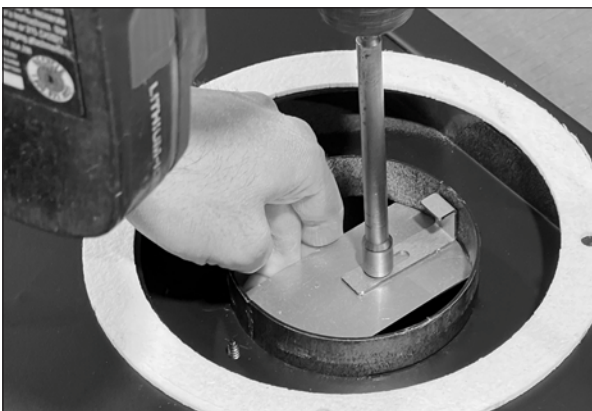

22. If the air restrictor ring is required, first determine the number of tabs that must be bent open. Before bending any tabs, align the mounting holes in the ring over the four pilot holes on the back of the fireplace. When selecting the tabs to bend, it is important to maintain the most symmetrical pattern possible. The first tabs bent must be opposite each other and oriented horizontally. If only one tab is specified, orient the ring over the pilot holes so the split tabs are oriented horizontally and bend up two opposing half-tabs. Additional tabs should be evenly spaced relative to the first two. With the appropriate tabs bent, re-align the mounting holes in over the pilot holes keeping the proper orientation AND with the bent tabs facing away from the fireplace body.

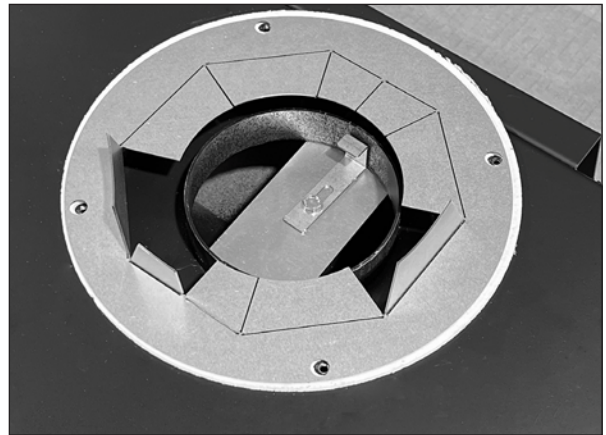

23. Align the inner pipe of the vent starter pipe with the exhaust outlet pipe on the fireplace. The vent pipe will fit tightly over the fireplace pipe. Gently push the starter pipe on to the fire-place pipe until the outer pipe flange makes contact with the vent pipe gasket. Be sure that the holes in the starter pipe flange align with the gasket and pilot holes. When the flange contacts the gasket, install the four fasteners provided with the starter pipe.



## ASSEMBLY & INSTALLATION

24. When the flange contacts the gasket, install the (4) #10, 5/16" fasteners provided with the starter pipe.



25. You are now ready to install the fireplace on the mounting plate. This will require a helper as the fireplace is quite heavy. Lift the fireplace up and guide the vent pipe into the vent pipe opening in the mounting plate. The vent pipe must be at the highest location possible in the vent pipe opening (almost touching the inner vent pipe heat shield) to allow the mounting tabs on the rear of the fireplace to clear the top of the mounting brackets on the mounting plate.

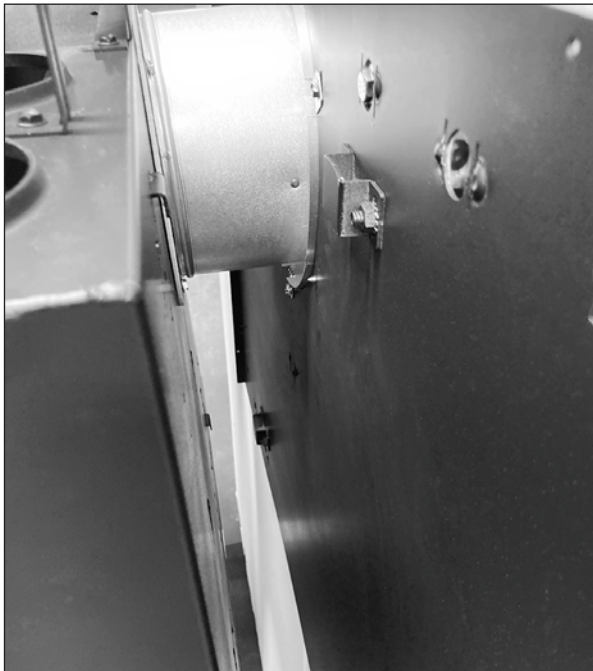

26. While looking in from the sides, guide the upper and lower mounting tabs on the back of the fireplace into the corresponding brackets on the mounting plate. When the tabs and brackets are aligned, push the fireplace down and in to engage the tabs in the brackets. **Note: The weight of the fireplace is carried only on the top brackets. The bottom brackets function simply to keep the bottom of the fireplace from moving. Refer to the photo below.**



27. If the fireplace is properly positioned on the brackets the vent starter pipe and vent heat shields should be concentric when viewed through the vent pass-through in the wall. Go outside and look in the hole to confirm this. If you are mounting the fireplace on a partition wall, look in the pass-through using a mirror if needed. If the vent starter pipe and vent pipe heat shields do not appear to be concentric, check to be sure that the mounting tabs on the fireplace are all fully engaged in the brackets on the mounting plate and that the upper two tabs are sitting down on the upper brackets. If they are not, adjust the fireplace until they are.

28. The image below is a view before installing Vent Termination Cap.



## ASSEMBLY & INSTALLATION

### Installing the Outer Vent Heat Shields and Vent Termination (Parallel Installation on Outside Wall)

1. Before you install the horizontal vent termination, you must first install the second halves of the two telescoping vent pipe heat shields. Each shield half simply slips over the half you previously attached to the fireplace mounting plate and can now be seen inside the vent pass-through in the wall.
2. Install the outer shield first and the inner second. Leave at least 2" of the shields protruding past the house sheathing.



3. Install the horizontal vent termination (vent cap). Be sure the arrow on the cap (if present) is pointing up and reconfirm that all the vent cap location requirements per page 18 and the vent manufacturers requirements are met.
4. Slip the inner and outer vent termination pipes onto the vent starter pipe taking care to align the inner and outer pipes to prevent damage.

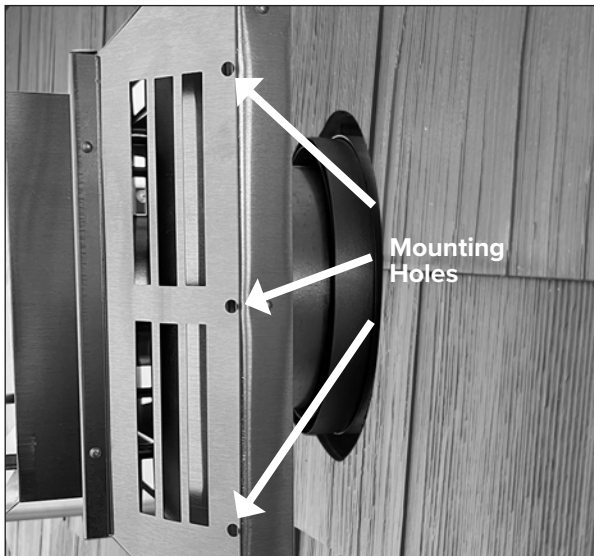

5. Slide the vent termination (cap) into the siding recess (or vinyl siding shield) until it bottoms out. **Note: The rear surface of the vent termination will push the telescoping vent pipe heat shields inward. When the vent termination is in place the heat shields will just touch the rear surface of the termination.**



6. Pull the vent cap away from the sheathing and install a small bead of non-hardening silicone sealer around the cap perimeter. Push the cap in place.
7. Install the mounting screws (included with the cap) to hold the vent cap to the sheathing. See the venting manufacturers instructions for the location of the mounting holes. Typical mounting hole locations are shown in the adjacent photo. See the venting manufacturers instructions for more information or if using the vinyl siding shield.

### Installing the Outer Vent Heat Shields (Partition Wall Installation)

1. Before you install the additional vent pipe and elbow(s) that will complete the venting installation, you must first install the second sections of the vent pipe heat shields to protect the combustible materials around the vent pipe pass-through in the partition wall that the fireplace is mounted on. Each shield half simply slips over the half you previously attached to the fireplace mounting plate and that can now be seen inside the vent pass-through in the partition wall.
2. Install the outer shield first and the inner second. Leave at least 2" of both shields protruding past the partition wall framing or wall covering. See photo to right →



### Vent Pipe Installation (Partition Wall Installation)

3. The specific details of the vent configuration from the vent starter pipe on the fireplace to the horizontal or vertical vent termination (cap) when the fireplace is installed on an interior wall of the house will vary depending on the location of the fireplace on the wall, what is on the back side of the wall, where the vent termination will be located (roof or exterior wall) and on other code requirements for the location of the vent termination as shown page 18. However, the maximum vent length, measured along the centerline of the pipe, from the back of the fireplace to the start of the vent termination cannot exceed 30 feet, including a maximum of 20 feet of vertical rise and a maximum of 10 feet of horizontal run. If more than two 90° elbows (or equivalent 45° elbows) are needed for your installation, the maximum amount of horizontal run allowed is reduced. See the venting section starting on page 11 for specific information. It is important to plan the installation in advance so that you can accurately locate any wall or ceiling pass-throughs and the vent termination on the exterior wall or roof. The vent pipe sections are available only in certain increments of length and in adjustable length sections. Plan carefully before you start!
4. You will find it helpful to leave access to the area behind the partition wall to facilitate installation of the vent components. The pipe sections may have twist lock connections which will be difficult to execute without good access.

5. Be sure that the two vent pipe heat shields extend at least 2" beyond the rear side of the partition wall adjacent to the fireplace after the venting is installed.
6. Maintain a minimum 1 ½" unobstructed air space around the vent pipe where it passes through other interior walls, the ceiling, the exterior wall or the roof.

**Note:** Vent manufacturer's instructions and some building codes may require the addition of blocking above and below all wall pass-throughs, the addition of vent manufacturer supplied fire-stops, wall thimbles, attic insulation shields, interior trim collars, vent support brackets, or other components. Please check with the authority having jurisdiction in your area when planning the venting installation to determine the specific code requirements and exact venting components that are required for your installation.

## ASSEMBLY & INSTALLATION

### Gas Supply Line

Once the vent pass-through (or pass-throughs) are finished, the gas supply line should be installed. The supply line should exit the wall that the fireplace will be installed on at the location specified on the installation template. We suggest the installation of a shut-off valve in the supply line between the wall and the connection to the fireplace. Your professional gas installer or local gas company will determine the specific requirements for the gas supply line as the requirements may vary in different locations. In every case, the installation must conform with local codes or, in the absence of local codes, with the National Fuel Gas Code, ANSI Z223.1 or the Canadian Installation Code, CAN/CGA B149.

### Gas Connection

1. Verify that the gas type is correct for the fireplace by looking at the rating plate that is attached to the right side of the fireplace, adjacent to the control battery pack. **Note: The fireplace is shipped from the factory equipped to burn the fuel listed on the rating plate. Conversion kit information and instructions are available on page 49.**
2. The gas connection should now be made from the gas supply line to the inlet on the fireplace. Use only a licensed gas installer to make the connection.
3. The fireplace is shipped from the factory with a  $\frac{3}{8}$ " tube OD (male) flare connection.
4. The gas supply piping should have a separate gas shut-off valve and a  $\frac{1}{8}$ " NPT plugged tapping upstream of the valve. We recommend installing a shut-off valve between the gas supply line where it penetrates the wall / fireplace mounting plate and the inlet to the regulator on the fireplace. This will allow gas to be shut-off to the fireplace by simply removing the fireplace surround to gain access to the shut-off valve.

**NOTE: The fireplace and its main burner valve must be disconnected from the gas supply piping system during any pressure testing of that system at test pressures in excess of  $\frac{1}{2}$  psi (3.5kPa).**

**NOTE: The fireplace must be isolated from the gas supply piping system by closing the gas shut-off valve during any pressure testing of the gas supply system at test pressures equal to or less than  $\frac{1}{2}$  psi (3.5kPa). After the gas supply has been connected, use a commercial gas leak detector or apply a soapy water solution to all the fittings to check for gas leaks. Never use a flame to test for leaks.**





## Installing or Replacing the Batteries

1. The valve control module is powered by (4) "AA" batteries. The batteries are mounted within the Valve Receiver Module located on the right side of the fireplace attached to a drop-down mounting bracket for easy accessibility. Refer to the adjacent photo.
2. Loosen the thumb screw on the module drop-down mounting bracket by turning counter-clockwise until the threads are fully disengaged from the base bracket.
3. Rotate the Valve Receiver Module and mounting bracket. Toward you 90°.
4. Slide off the Battery compartment cover.
5. Install the (4) "AA" batteries, supplied, using the guides inside the battery pack to show you the correct battery orientation.
6. Replace the battery compartment cover. Rotate the Valve Receiver Module and mounting bracket into its home position and tighten the thumb screw to secure.
7. The remote handset is powered by (2) "AAA" batteries. The access panel is located on the back of the handset and simply snaps open to provide access to the battery compartment. Install the three batteries as shown on the label inside the remote control battery compartment.
8. Replace the remote handset access panel.



## Placing the Burner Glass Media

**SÓLAS Fireplaces come standard with a Glass Burner and Glass Media. If you have the optional SÓLAS Log Set/Log Set Burner, please refer to the separate Log Set Installation Manual for instructions.**

The burner glass media poly bag that you set aside when you unpacked the fireplace contains the correct amount of glass material to cover the burner. The entire contents of the bag should be evenly distributed over the burner tray.

1. Locate the burner in the fireplace. Refer to the adjacent photo.
2. Carefully clip one corner of the poly bag to form a pouring spout. The opening should be large enough to allow the glass media to flow but not so large that you can't control the flow.
3. You will notice that the burner surface is designed with turned-up edges that form a tray to hold the glass media.



Burner Tray

## ASSEMBLY & INSTALLATION

### Placing the Burner Glass Media (continued)

- Starting at one end, pour the glass media onto the burner tray, keeping the pouring spout on the poly bag toward the center of the burner to avoid spillage of glass pieces over the sides of the burner. See the adjacent photos.
- Once you have poured all of the glass burner media into the burner tray, carefully smooth the glass pieces out so they have a uniform depth over the entire surface of the burner. When the burner glass media is properly placed, it should look like the adjacent photos.
- NOTE:** If a few pieces of glass escape over the edges of the burner tray during installation, it is not a problem. They will simply land in the area below the burner and will do no harm.



Burner Glass Media partially installed



Burner Glass Media fully installed

### Relief Door Installation

- The top relief door is shipped separate from the fireplace and must be installed on the top of the firebox at this point in the installation. **NOTE: The relief door includes a gasket that covers the full bottom surface. Use care in handling the relief door to avoid damage to the gasket material.**
- The first image shows the relief openings and relief door retainers.
- The relief door includes line-up tabs that correspond to slotted retainers on the firebox.
- Tip the relief door enough to allow the rear line-up tab to engage the rear retainer slot. Refer to the second image.
- Rotate the front edge of the relief door so it lines-up over front retainer.
- Gently spring the front forward so it will allow the relief door front line-up tab to engage on the retainer. Refer to the first image on the top of the next page.
- The relief door should be able to move up and down freely on the retainers if properly installed.
- When the relief door installation is complete, the door should be in the full down position. Refer to the second image on the top of the next page.

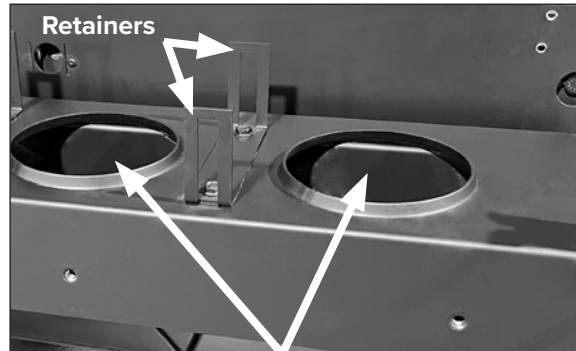

Relief Openings

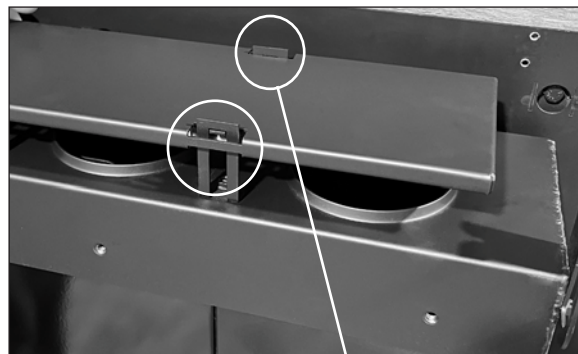

Relief Door  
Front Tab

Relief Door Rear Tab  
Engaged with Rear  
Retainer

## ASSEMBLY & INSTALLATION

### Relief Door Installation (con't)



Relief Door front tab engaged on retainers



Relief Door shown in proper operating position

### Installing the Front Glass Panel and Frame

After burner media and the relief door have been installed, the next step is to replace the front glass panel and frame.

1. Carefully pick up the glass and glass frame assembly by grasping the sides of the frame and using your thumbs and fingers to hold the glass in place within the gasket and frame.
2. With the glass frame (and glass) held at a slight angle (leaving room for your fingers between the frame and the firebox) insert the bottom edge of the frame into the frame retainer located on the bottom front of the firebox. Take care to center the frame from left to right.



3. Once the bottom edge is in place, move your fingers out of the way and press the top of the frame against the firebox while pushing down to be sure the frame is fully engaged in the frame retainer.

4. Hold the frame in place with one hand and insert the four glass frame fasteners along the top edge of the glass frame. Tighten the fasteners until they are hand-tight.
5. Tighten each fastener  $\frac{1}{2}$  turn at a time, working from one side to the other, until the glass frame has made contact with the firebox face along the entire top edge. Do not over-tighten the fasteners as this can put excessive stress on the glass.



6. Fireplace must not be used without relief door installed. Relief door openings must be covered by relief door, and the relief door must be able to slide freely on the retainers.

## ASSEMBLY & INSTALLATION

### Installing the Outer Panels

The outer top and bottom panels are secured to the fireplace mounting plate with sheet metal screws. All other screws are philips head machine screws.

1. Install the outer top panel first. Align the three holes along the rear edge of the panel with pilot holes along the top edge of the fireplace mounting plate. Insert and tighten the three sheet metal screws. A magnetic nut driver is helpful.

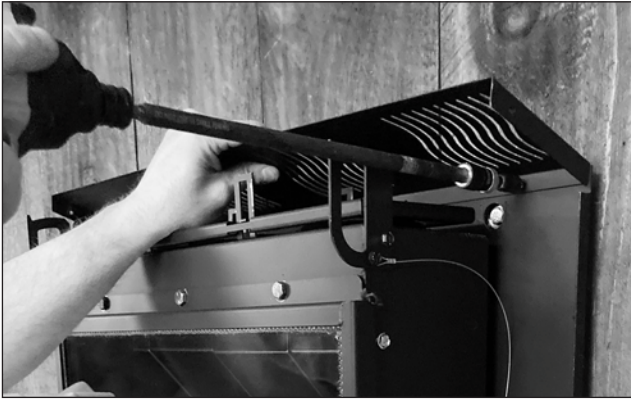

2. Install the outer left side panel next. Align the three holes along the rear edge of the panel with the PEM nuts along the edge of the fireplace mounting plate. Insert the three philips head screws but do not fully tighten.



3. Locate the fastener hole at the top front edge of the outer left side panel and align with the PEM nut in the front of the top panel. Insert the philips head screw.

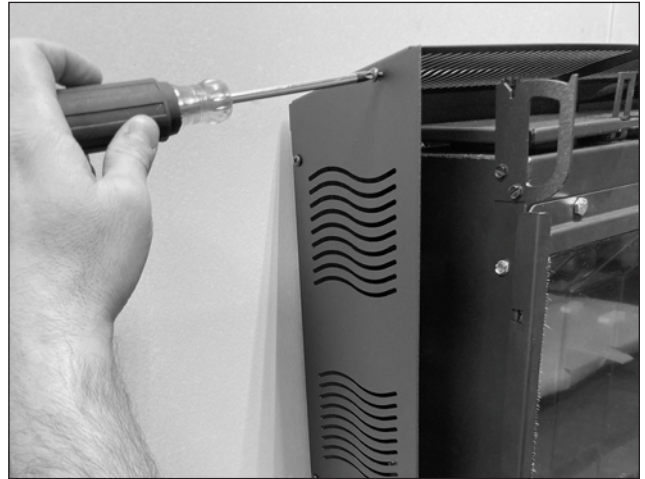

4. Make sure the edges of the panel are aligned with the edges of the top outer panel and mounting plate and tighten all four philips head screws.
5. Position the outer right side panel so it aligns with the three PEM nuts on the mounting plate and the front PEM nut on the top panel. Align the rear and outer top panel edges with the adjoining parts and insert and tighten the four philips head screws.
6. Install the outer bottom panel next. Guide the rear flange on the panel upward until the mounting holes in the flange line up with the pilot holes in the mounting plate.

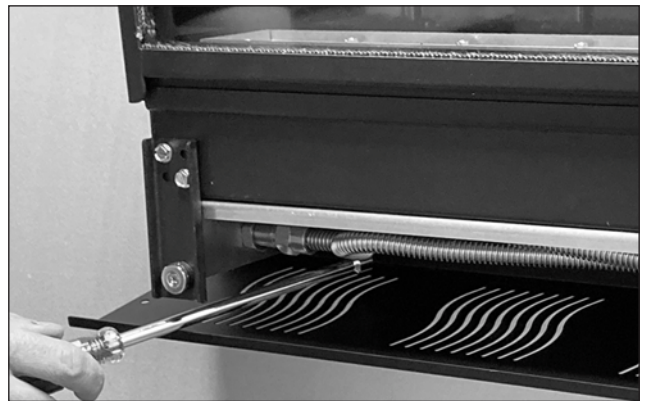

7. Attach the panel to the mounting plate using sheet metal screws along the back edge of the panel. **Note:** It may make installation of the sheet metal screws easier if you remove the two lower surround mounting brackets from the front of the fireplace. A magnetic nut-driver will also be helpful.

## ASSEMBLY & INSTALLATION

### Installing the Outer Panels (con't)

8. Attach the outer bottom panel to the outer side panels by aligning the fastener holes in the bottom panel with the PEM nuts in the front corners of the bottom flanges on the outer side panels. Insert and tighten the two philips head screws.



9. Reinstall the lower surround brackets if you removed them by inserting and tightening the two sheet metal screws in each bracket.
10. Only trim kit(s) supplied by the manufacturer shall be used in the installation of this appliance.

### Installing the Fireplace Surround with Integrated Screen

The decorative surround with integrated screen for the fireplace is held in place by four brackets. Two are located on the top of the fireplace and two on the bottom. There are mating brackets and catch plates on the surround itself. Refer to the adjacent photos when installing the surround.

1. Unpack the surround with integrated screen from shipping box.
2. With a helper, lift the surround with integrated screen up and identify the top by looking for the vertical brackets that are visible from the rear of the surround.



3. Move the surround with integrated screen into place, generally centering the surround opening over the glass panel. Keep the bottom of the surround tipped slightly away from the fireplace.

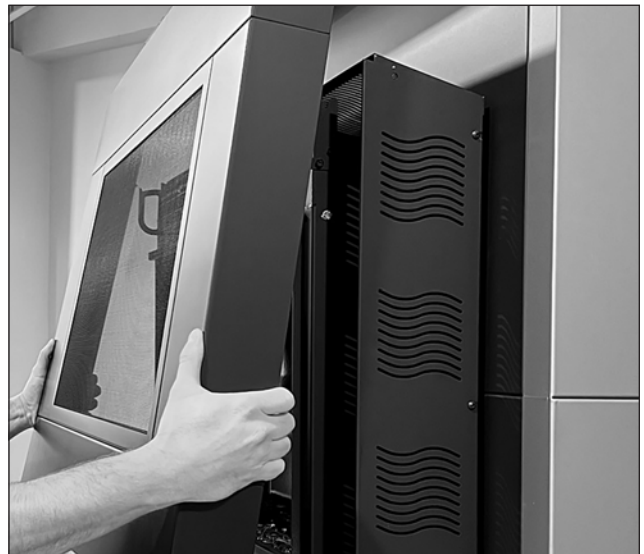

## ASSEMBLY & INSTALLATION

4. While looking behind the surround with integrated screen, guide the two surround brackets onto the forward detent of the mating brackets on the fireplace top. You might find it easier to engage one bracket and then the other. Lower the surround until both bracket sets are fully mated.

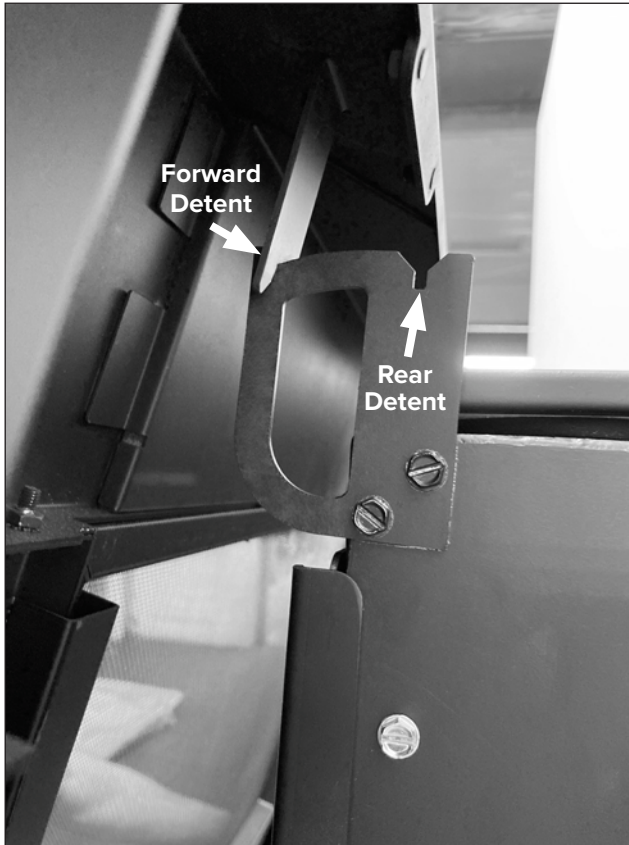

5. Carefully push the top of the surround with integrated screen so that the surround brackets slide into the rear detent of the mating brackets on the fireplace top.

6. Carefully swing the bottom of the surround with integrated screen toward the base of the fireplace until each of the L brackets on the surround are aligned with the magnets on the fireplace, holding the bottom of the surround securely on the fireplace.



7. To remove the surround with integrated screen, pull the bottom edge of the surround outward to disengage the magnets and then lift the top up and off the upper brackets.
8. To prevent damage to the surround with integrated screen, always set the surround in a safe place while it is removed from the fireplace.

## FIRST FIRE INSTRUCTIONS

When operating your new fireplace for the first time, some vapors may be released due to the curing compounds used in the manufacture of the appliance. They may cause a slight odor and could cause the flames to be the full height of the firebox, or even slightly higher, for the first few hours of operation. It is possible that these vapors could set off smoke detection alarms in the immediate vicinity. These vapors are quite normal on new appliances. We recommend opening a window to vent the room during the burn off period. After a few hours use, the vapors will have disappeared and the flames will be at their normal height.

Where applicable, it is important that the blower is turned on to help clear the vapors from the unit.

### Follow these instructions for a successful first fire;

1. Turn the fireplace on in Manual Mode.
2. Set flame height to HI.
3. Let the fireplace run for **3 hours** at this setting then shut off fireplace and let it cool.
4. After the fireplace cools, turn the fireplace on in manual mode with flame on HI and the blower off.
5. Allow fireplace to run for **6 hours** in this setting.

**NOTE:** Slight Odors may still be noticed on future uses of the fireplace but will diminish over time. The type of finishing materials used around the fireplace may add odors or add to the curing time. If the fireplace has not been used in several months, it is normal for odors to occur caused by lint or dust that has settled on the unit while not in use.

## FLAME SUPERVISION DEVICE

For your safety, this appliance is fitted with a flame supervision device which will shut-off the gas supply if, for any reason, the pilot flame goes out. This device incorporates a fixed probe, which senses the heat from the pilot flame. If the probe is cool, the device will prevent any gas flow unless manually lighting the pilot. See full lighting instructions.

**NOTE:** Periodically conduct a visual check to ensure the pilot and burner flames are as shown (top of page 40).

During extreme cold weather, it is recommended that you leave the pilot running to prevent condensation forming in the firebox and on the glass viewing area during startup.

## LIGHTING, OPERATION & RATING INFO

The Lighting, Operation and Rating information is located on a plate on the RH side of the firebox.

To access the plate, remove the surround and grab the plate and slide it up to read it. There is important information on both sides of the plate.

## WARNING

**DO NOT ATTEMPT TO TOUCH THE DATA PLATE WHILE THE FIREPLACE IS STILL HOT!**  
Let the fireplace cool first before touching it.

## SERVICING

If any attention is required for your appliance, contact your dealer quoting the model number and serial number. This number is on the rating plate, which is located adjacent to the control module. The replacement parts are shown at the end of this manual. Please always quote the part number and description when requesting spare parts. Warranty is void if serviced by a non-licensed technician.

## FIREPLACE CONTROL DEVICES

There are two ways to control your fireplace.

1. SÓLAS One-Touch Remote (**S-507**)
2. Optional Wall Touch Pad (**WTP-1500**)

The SÓLAS One-Touch Remote can be programmed to function automatically—see pages 41-48.

The Optional Wall Touch Pad can be used to turn the flame on, off, and to increase or decrease the flame height.

**NOTE: The SÓLAS One-Touch Remote in the AUTO mode will override the Wall Touch Pad.**

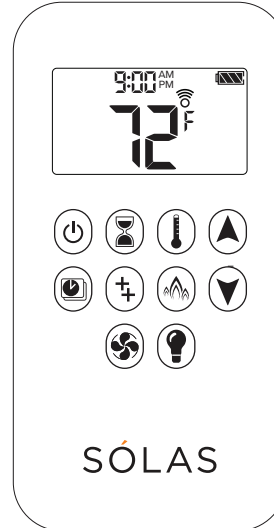

SÓLAS One-Touch Remote Part #S-507

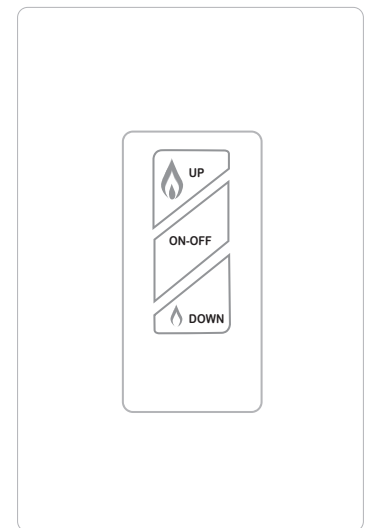

Wall Touch Pad Part #WTP-1500 (Optional)

**NOTE: The Wall Touch Pad is not compatible with the SÓLAS Self-Calibrating Power Vent System.**

**WARNING:** If you do not follow these instructions exactly, a fire or explosion may result causing property damage, technician injury or loss of life.

When lighting this appliance, follow instructions exactly.

- A. This appliance is equipped with an ignition device that automatically lights the pilot. Do not try to light the pilot by hand.
- B. BEFORE OPERATING THE BURNER SYSTEM, smell around the appliance area for gas. Be sure to smell next to the floor because some gas is heavier than air and will settle on the floor.

### WHAT TO DO IF YOU SMELL GAS

- Do not try to light the appliance.
- Do not touch any electric switch; do not use any telephone in your building.
- Immediately call your gas supplier from a neighbor's telephone. Follow the gas supplier's instructions
- If you cannot reach your gas supplier, call the fire department.
- C. Use only your hand to operate the gas controls. Never use tools. If a knob will not push in or turn by hand, don't try to repair it, call a licensed service technician. Force or attempted repair may result in a fire or explosion.
- D. Do not use this appliance if any part has been under water. Immediately call a licensed service technician to inspect the appliance and to replace any part of the control system which has been under water.

## OPERATING INSTRUCTIONS

1. STOP! Read the safety information above on this label.
2. This appliance is equipped with an ignition device that automatically lights the pilot. Do not try to light the pilot by hand.
3. Confirm that the remote LCD display says "OFF". Visually check there is no pilot flame visible inside the fireplace.
4. Wait five (5) minutes to clear out any gas. Then smell for gas including near the floor. If you smell gas, STOP! Follow "B" in the safety information above. If you don't smell gas, proceed to step 5.
5. Using either the Remote or the optional Wall Touch Pad, press and hold the "ON/OFF" button for 4 seconds. An audible signal confirms the start sequence has begun.
6. Continuing beeps confirm the ignition is in process. Once lighting the pilot flame should appear as shown below. Once the pilot is confirmed, the main burner ignites on high.

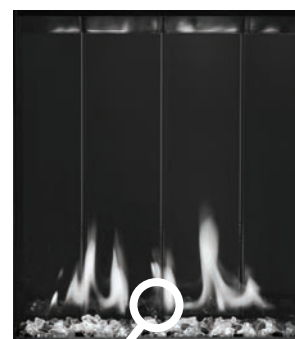
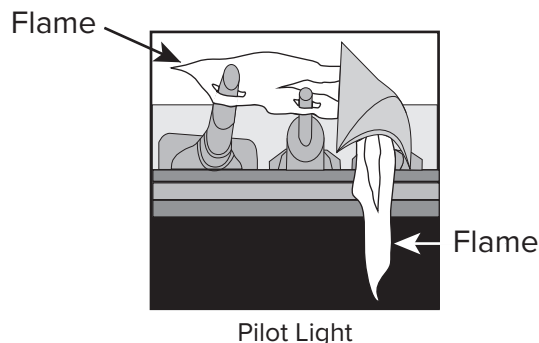

Pilot Light Location

**NOTE:** If the pilot does not stay lit after several tries, proceed to step 9.

7. Use the flame height adjustment buttons on either the Remote or the optional Wall Touch Pad to adjust the flame. To increase flame height, press and hold ▲. To decrease flame height, press and hold ▼.
8. Press and hold the ▼ button on the Remote or optional Wall Touch Pad to set the appliance to Pilot flame only.
9. If the appliance will not operate, follow the instructions "TO TURN OFF GAS TO THE APPLIANCE" and call your gas service technician or gas supplier.

## TO TURN OFF GAS TO THE APPLIANCE

1. To turn off gas to the appliance, push and release the "OFF" button on either the Remote or the optional Wall Touch Pad. An audible signal will confirm.
2. TO TURN OFF THE GAS SUPPLY TO THE APPLIANCE, close the shut-off valve on the gas supply line to the appliance.

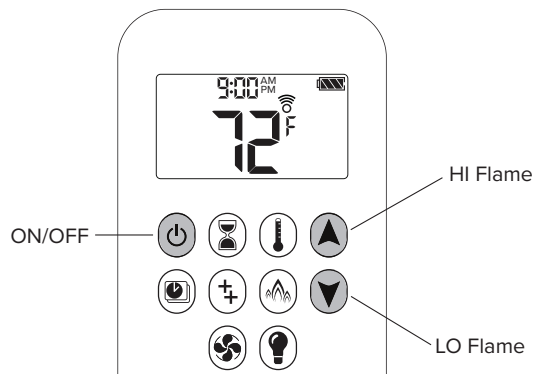



## SÓLAS ONE-TOUCH REMOTE PAIRING SET-UP

The Control Module and the Remote must be paired before the first use. This has been completed for you at the factory. Refer to the section below if the Control Module and Remote lose synchronization.

1. Insert two AAA alkaline batteries in the Remote. Only use brand name alkaline batteries, such as Duracell or Energizer.
2. Four AA alkaline batteries are installed in the Control Module (shown below).
3. Locate the RESET button on the front side of the Control Module.
4. Press and hold the Control Module's RESET button until you hear one short beep and one long beep. After the second beep, release the reset button.
5. Within the subsequent 20 seconds, press and hold the  button on the Remote for 2-3 seconds. **COMM** will be displayed and flash on the Remote during the pairing sequence. The Remote will count up from 1 to 8, and you will hear two short beeps confirming the pairing is complete.

If you hear one long beep, the pairing sequence has failed or the wiring is incorrect.

*This is a one time pairing and is not required when changing the batteries of the Remote or Control Module. The remote control system is now ready to use.*

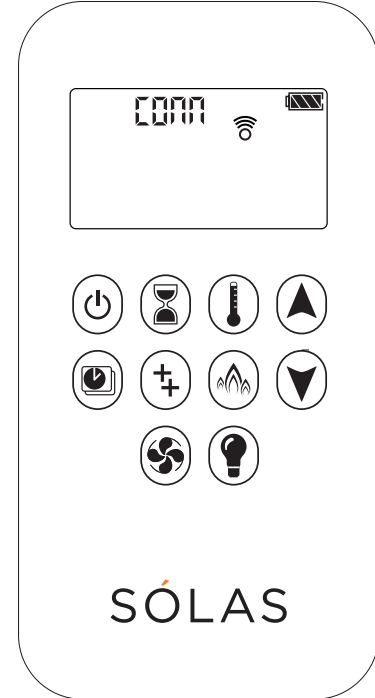

SÓLAS One-Touch Programmable Thermostatic Remote Part #S-507



SÓLAS One-Touch Control Module Part #S-504

**NOTE: The batteries in your SÓLAS One-Touch remote control and control module are to be replaced annually.**

RESET Button

# SÓLAS ONE-TOUCH REMOTE OPERATION

## HOW TO TURN YOUR FIREPLACE OFF (INCLUDING PILOT)

Familiarize yourself with each of these methods before operating your fireplace.

**Remote and Wall Touch Pad:** Press and hold the ON-OFF button for a second (either on the Remote or the optional Wall Touch Pad).

If the flames are on, they go down and you hear the valve motor wind down. You hear a clunk and a beep indicating that the valve has received the signal from the Remote.

## HOW TO ENSURE YOUR FIREPLACE CANNOT BE TURNED ON INADVERTENTLY

You can use the following method to ensure that your fireplace will not turn on when you don't want it on.

First, ensure your fireplace is turned off—including the pilot—and cold BEFORE going ahead.

- Close the shut-off valve on the gas supply line to the appliance.
- Remove all batteries from the Control Module as well as the batteries from the Remote.
- If unit is hardwired, shut-off power at the breaker.

### Automatic Shut-Off (in certain conditions)

Your fireplace's Remote is equipped with an automatic shut-off mechanism which is activated in certain conditions. See page 47 in the Remote Control Operation section for a description of this feature.

**NOTE:** Before using the remote control system for the first time, the Control Module and the Remote are synchronized at the factory. See the section SÓLAS Remote Pairing Set-up on page 41 of this manual if the Control Module and Remote lose synchronization.

**IMPORTANT:** BEFORE YOU BEGIN, please note that with this system, the settings of time, temperature and automatic ON/OFF can only be programmed when the function display is flashing. Be patient when programming as it does take time to set-up.

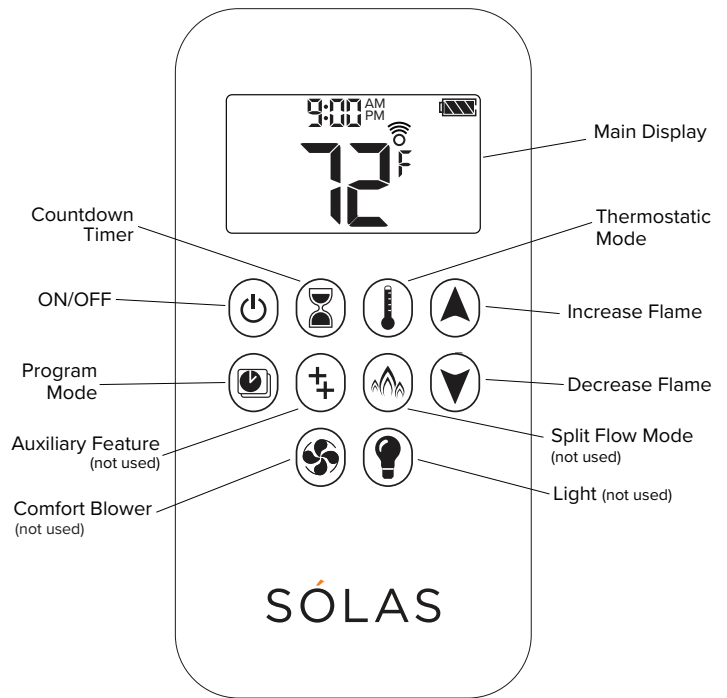

SÓLAS One-Touch  
Programmable  
Thermostatic Remote  
Part #S-507

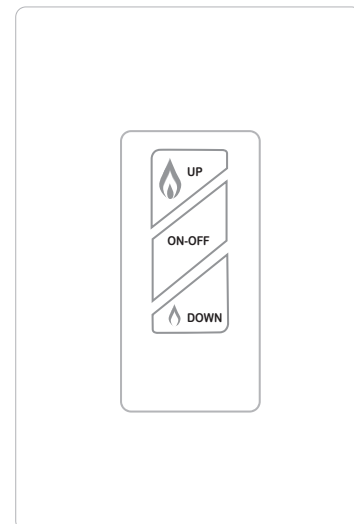

SÓLAS Wall Touch Pad\*  
(Optional)  
Part #WTP-1500

\*Not Compatible with SÓLAS Self-Calibrating Power Vent Kit

# SÓLAS

## ONE-TOUCH REMOTE MAIN DISPLAY OVERVIEW

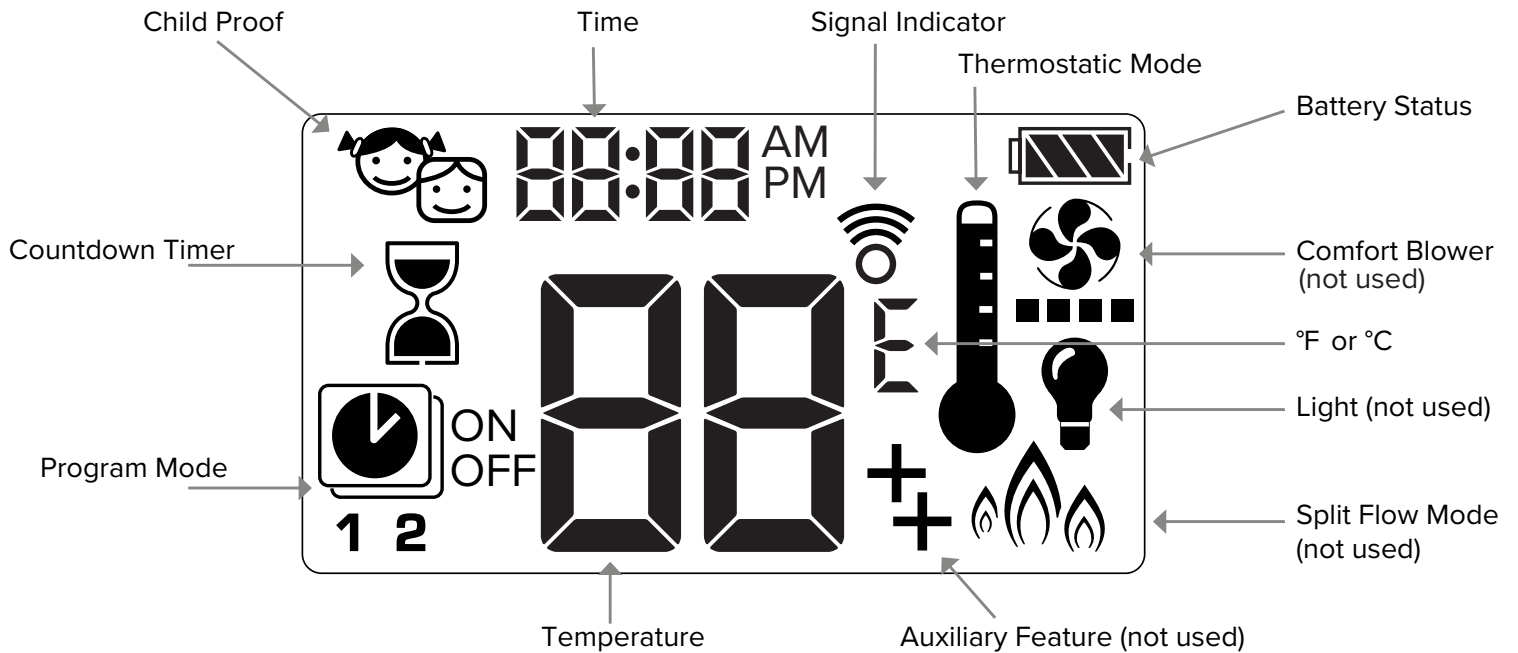

**DO NOT** leave the Remote on the hearth, mantel, or on top of the fireplace. Use the Remote wall mount holder provided.



The SÓLAS One-Touch Remote Control comes with a wall bracket. Mount the wall bracket in the same room as the fireplace. Approximately 8-10 feet from the fireplace.

# SÓLAS ONE-TOUCH REMOTE OPERATION

## TO TURN ON FIREPLACE

### CAUTION

WHEN PILOT IGNITION IS CONFIRMED, MOTOR TURNS AUTOMATICALLY TO MAXIMUM FLAME HEIGHT.

One-Touch Lighting (default): 

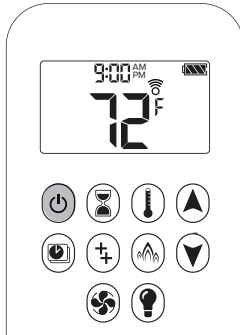



Press and hold  for 4 seconds, until 8 short beeps and a blinking series of lines confirms the start sequence has begun. Release button.

Main gas flows once pilot ignition is confirmed.

Remote automatically goes into manual mode after main burner ignition. The fireplace will default to HI flame.

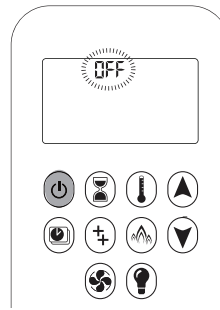
## TO TURN OFF FIRE



- Press  to turn OFF. When the pilot is off, it will take 2 minutes before it can be lit again.

**NOTE:** There is a 2 minute delay after switching off before the next ignition is possible.

### CAUTION

Always check the fire and pilot visually to ensure they are off.

## STANDBY MODE (PILOT FLAME)

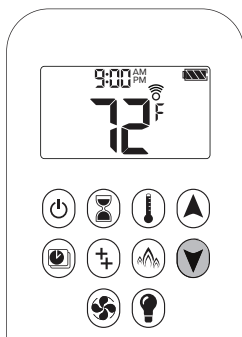

Press and hold  to set appliance to pilot flame.

## FLAME HEIGHT ADJUSTMENT

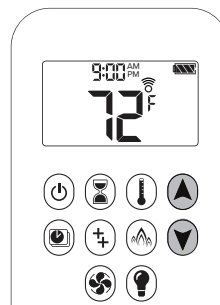

To increase flame height, press and hold .

To decrease flame height, press and hold . You may hold the button down until the fire is set to pilot flame only.

### CAUTION

If the pilot does not stay lit after several tries call your local service technician or gas supplier.

## DESIGNATE LOW AND HIGH FIRE



Double-Click DOWN Arrow  button. "LO" is displayed.

**NOTE:** Flame goes to high fire first before going to designated low fire.

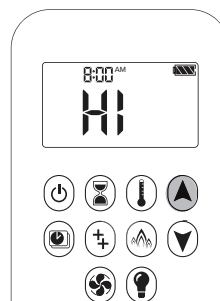

Double-Click UP Arrow  button. Flame automatically goes to high fire. "HI" will be displayed.

# SÓLAS ONE-TOUCH REMOTE OPERATION

## SETTING CELSIUS OR FAHRENHEIT

To change between °C and °F, press and hold + simultaneously.

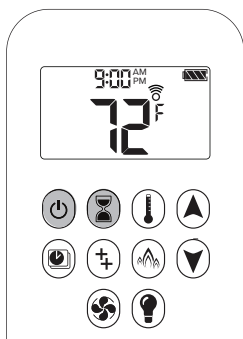

**Note:** When Remote is in °C (Celsius) mode the clock will be 24-hour. When Remote is in °F (Fahrenheit) mode the clock will be 12-hour.

## SETTING THE TIME

1. Press + simultaneously. **Day** flashes.
2. Press + to select a number to correspond with the day of the week.
  - 1 = Monday
  - 2 = Tuesday
  - 3 = Wednesday
  - 4 = Thursday
  - 5 = Friday
  - 6 = Saturday
  - 7 = Sunday
3. Press + simultaneously. **Hour** flashes.
4. To select hour press or .
5. Press + simultaneously. **Minutes** flash.
6. To select minutes press or .
7. To confirm, press or simultaneously or wait.

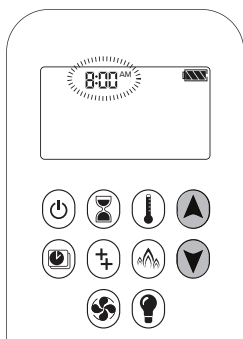

## CHILD PROOF

Your Remote can be set to lock out all commands to the fireplace, except OFF.

### To turn Child Proof ON:

1. Press and hold + simultaneously.
2. is displayed. Child Proof is now active.

### To turn Child Proof OFF:

1. Press and hold + simultaneously.
2. disappears. Child Proof is now inactive, and the Remote has full function.

## COUNTDOWN TIMER

You can set your fireplace to automatically turn off at the end of a timer.

### To set a Countdown Timer:

1. Press and hold until is displayed. **Hour** flashes.
2. Press or to select Hour.
3. To confirm, press . **Minutes** flash.
4. Press or to select Minutes.
5. To confirm, press or wait.

### To turn off a Countdown Timer:

1. Press , and the countdown disappears.

**NOTE:** The Countdown Timer only works in Manual and Thermostatic modes. Maximum countdown time is 9 hours and 50 minutes.

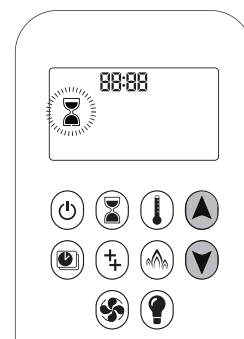

# SÓLAS ONE-TOUCH REMOTE OPERATION

## MODES OF OPERATION

### Manual Mode

The ON/OFF status of the fireplace, as well as flame height, are manually controlled by the user.

### Thermostatic Mode

The room temperature is measured and compared to the set temperature. The flame height is automatically adjusted to achieve the set temperature.

#### ON:

Press . is displayed. Preset temperature displays briefly, followed by the room temperature.

#### Setting Desired Temperature:

1. Press and hold until is displayed and set temperature flashes.
2. To adjust set temperature, press or .
3. To confirm, press or wait.

#### OFF:

1. Press .
2. Press or to go to Manual Mode.
3. Press to go to Program Mode.

### Program Mode

The temperature is controlled by Programs 1 and 2, each of which can be set to go on and off at specific times, at a set temperature.

## PROGRAM MODE

#### ON:

Press . , 1 or 2, **ON** or **OFF** are displayed.

#### OFF:

1. Press , or to go to Manual Mode.
2. Press to go to Thermostatic Mode.

**NOTE:** The set temperature for Thermostatic Mode is the temperature for the ON time in Program Mode. Changing the Thermostatic Mode set temperature also changes the ON time temperature in Program Mode.

#### Default Settings:

- ON TIME (Thermostatic) TEMPERATURE: 70°F / 21°C
- OFF TIME TEMPERATURE: " " (pilot flame only)

#### Temperature Setting:

1. Press and hold until flashes. **ON** and set temperature (set in Thermostatic Mode) is displayed.
2. To continue, press or wait. , **OFF** displayed, temperature flashes.
3. Select off temperature by pressing or .
4. To confirm, press .

**NOTE:** The on (Thermostatic) and off set temperatures are the same for each day.

#### Day Setting:

1. ALL flashes. Press or to choose between:
  - **ALL** = same settings ON-OFF every day
  - **SA:SU** = same settings ON-OFF Saturday and Sunday
  - **1, 2, 3, 4, 5, 6, 7** = daily timer—unique ON-OFF settings for a single day of the week, for multiple days of the week or for every day of the week.
2. To confirm, press .

#### ALL Selected

##### On Time Setting (PROGRAM 1)

1. , **1**, **ON** are displayed. **ALL** is displayed briefly. Hour flashes.
2. To select hour, press or .
3. To confirm, press . , **1**, **ON** are displayed. **ALL** displayed briefly. Minutes flash.
4. To select minutes, press or .
5. To confirm, press .

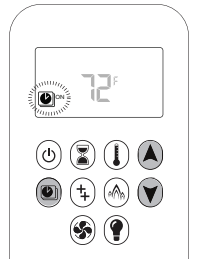
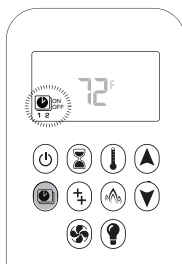
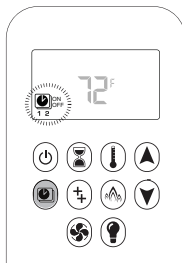
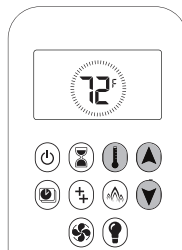
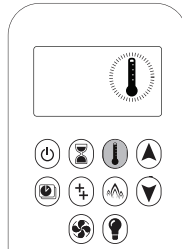

# SÓLAS ONE-TOUCH REMOTE OPERATION

## PROGRAM MODE (Continued)

### Off Time Setting (PROGRAM 1)

1. , **1**, **OFF** are displayed. **ALL** is displayed briefly. Hour flashes.
2. To select hour, press or .
3. To confirm, press . , **1**, **OFF** are displayed. **ALL** displayed briefly. Minutes flash.
4. To select minutes, press or .
5. To confirm, press .

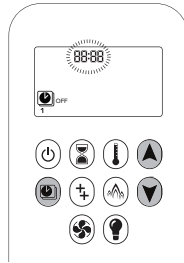

**NOTE:** Either continue to PROGRAM 2 and set ON and OFF times or stop programming at this point, and PROGRAM 2 remains deactivated.

**NOTE:** PROGRAM 1 and 2 use the same ON (Thermostatic) and OFF temperatures. Once a new ON (Thermostatic) and/or OFF temperature has been set, that temperature becomes the new default setting.

**NOTE:** ON and OFF times programmed for PROGRAM 1 and PROGRAM 2 become the new default times.

The batteries must be removed to clear the PROGRAM 1 and PROGRAM 2 ON and OFF times and temperatures.

### SA:SU or Daily Timer (1-7) Selected

- Set ON time and OFF time using the same procedure as “**ALL** Selected” above.
- Waiting to finish setting.

## LOW BATTERY INDICATION

### CAUTION

**Do not use a screwdriver or other metallic object to remove the batteries from the Control Module battery holder or the Remote. This could cause a short circuit.**

**NOTE: The batteries in your SÓLAS One-Touch remote control and control module are to be replaced annually. Only use brand-name alkaline batteries such as Duracell or Energizer.**

### Remote

The battery icon will show when the battery needs to be replaced. Replace with two 1.5 V AAA alkaline batteries.

### Control Module

Frequent beeps for 3 seconds when the motor turns indicate the batteries in the battery holder of the Control Module need to be replaced. Replace with four 1.5 V AA alkaline batteries.

## AUTOMATIC SHUT-OFF

### Countdown Timer

At the end of countdown time period, the fire turns off. The Countdown Timer only works in Manual and Thermostatic. Maximum countdown time is 9 hours and 50 minutes.

### Seven Day Shut Off

If there is no activity for 7 days, the SÓLAS fireplace will automatically shut down the pilot as required by certain jurisdictions.

## AUTOMATIC TURN DOWN



### 3 Hour No Communication Function

If your fireplace and remote are inactive for three hours—for example, if the remote is left in another room—your fireplace automatically turns down to pilot.



### Benefit

*SÓLAS products are designed with a focus on safety and environmental responsibility. This will help save fuel and is an environmental benefit. Program the temperature and timer modes to maximize your heating efficiency.*

## SÓLAS ONE-TOUCH REMOTE OPERATION

ERROR CODE	MESSAGE	DURATION OF DISPLAY	SYMPTOM	POSSIBLE CAUSE
F04	F04	4 seconds	<ul style="list-style-type: none"> <li>No pilot flame within 30 sec</li> <li><b>Note:</b> After 3 failed ignition sequences, F06 shown</li> </ul>	<ul style="list-style-type: none"> <li>No gas supply</li> <li>Air in pilot supply line</li> <li>No spark</li> <li>Reversed polarity in thermocouple wiring</li> </ul>
F06	F06	4 seconds	<ul style="list-style-type: none"> <li>3 failed ignition sequences in 5 minutes</li> <li>Fire is not responding, no pilot flame</li> </ul>	<ul style="list-style-type: none"> <li>No gas supply</li> <li>Air in pilot supply line</li> <li>No spark</li> <li>Reversed polarity in thermocouple wiring</li> <li>Incorrect pilot orifice if valve has been converted from LPG to NG or vice versa</li> </ul>
F07	Low Battery Symbol 	Permanent	<ul style="list-style-type: none"> <li>Battery icon flashes on Remote display</li> </ul>	<ul style="list-style-type: none"> <li>Low battery in Remote</li> </ul>
F09	F09	4 seconds	<ul style="list-style-type: none"> <li>Fire is not responding</li> <li>No electronic control of fire</li> </ul>	<ul style="list-style-type: none"> <li>Down arrow button  was not pressed during pairing</li> <li>Control Module and Remote are not synced</li> </ul>
F46	F46	4 seconds	<ul style="list-style-type: none"> <li>Fire is not responding</li> <li>Intermittent response</li> <li>No electronic control of fire</li> </ul>	<ul style="list-style-type: none"> <li>No or bad connection between Control Module and Remote</li> <li>No power at Control Module (batteries low)</li> <li>Low communication range (main adapter faulty, Remote not communicating with Control Module)</li> </ul>

### SÓLAS ONE-TOUCH REMOTE TIPS

- Double-click  to go directly to **LO** (lowest) flame setting.
- Double-click  to go directly to **HI** (highest) flame setting.
- Only use brand name alkaline batteries, such as Duracell or Energizer.
- When using the Remote, it should be within 15 feet (4.5 meters) of the fireplace.
- Don't leave the Remote on the mantel or hearth or any hot surfaces. Use the Remote wall holder provided.
- To keep out of children's reach, use the Remote wall holder provided.
- Be patient when programming: it takes time to set-up.
- Once you turn a pilot off, it takes a few minutes before you can turn it back on.

**Your SÓLAS Dealer is here to help, if you have any trouble with your SÓLAS Fireplace or SÓLAS One-Touch Remote. Please contact your Dealer for support.**



## GAS CONVERSION

This appliance is field convertible when a SÓLAS gas conversion kit is used. Gas conversions must be performed by a licensed service technician. Before servicing the appliance, shut off gas and electrical power to the unit.

PART #	DESCRIPTION	SÓLAS CONVERSION KIT CONTENTS			
SL16-LPC	<b>ONE6 LP</b> CONVERSION KIT	#27 PILOT ORIFICE	#58 LP BURNER ORIFICE – 1PC	#8 SCREW – 1PC	Gas Conversion Labels
SL16-NGC	<b>ONE6 NG</b> CONVERSION KIT	#35 PILOT ORIFICE	#53 NG BURNER ORIFICE – 1PC	NG Inlet Tube Collar–1PC #8 SCREW – 1PC	Gas Conversion Labels

1. Remove the surround with integrated screen. Pull the bottom edge of the surround outward to disengage the magnets and then lift the top up and off the upper brackets. To prevent damage to the surround with integrated screen, always set the surround in a safe place while it is removed from the fireplace.



2. Remove front glass panel and frame. Refer to page 35 (**Installing the Front Glass Panel and Frame section**) Reverse steps starting with Step 5 and end with Step 1.

3. Remove the bottom outer panel by removing the #10 sheet metal screws, using a 5/16 nut driver or ratchet with extension.

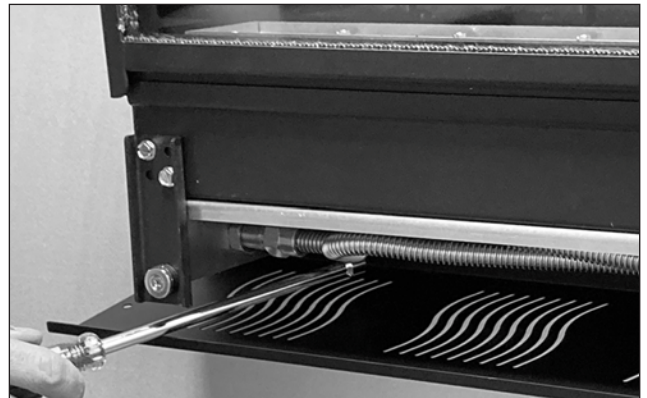

4. Remove the 2 Phillips head screws from the outer edges of the bottom outer panel.



## GAS CONVERSION

5. Locate and remove the (4) #10 sheet metal screws that hold the burner into the firebox. These are located on the outer edges below the burner. See photos below.

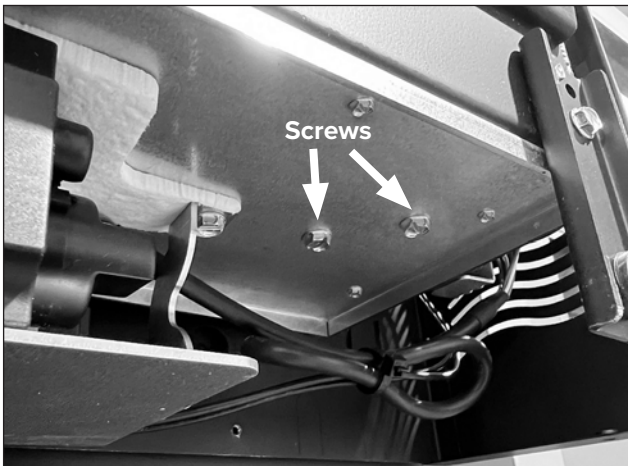
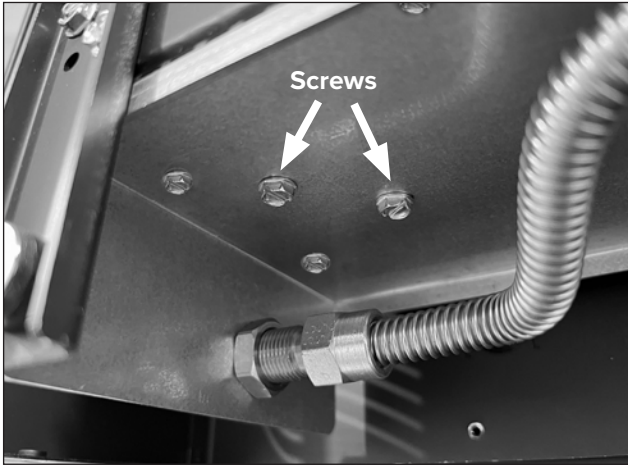

6. Slide the burner to the right and then up to disengage from orifice.



7. With the burner out of the fireplace, using a 9/16" deep socket, remove the orifice and replace it with the correct fuel you are converting to.



8. Next convert the burner to the fuel desired. When converting to propane, remove the collar on the burner inlet tube. When converting to natural gas install the collar over the burner inlet tube and secure with a #8 sheet metal screw provided using a 1/4" nut driver.



Collar OFF for LP

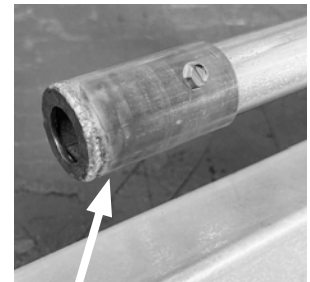

Collar ON for NG

9. Remove the (2) #10 sheet metal screws using a 5/16" nut driver that hold the pilot assembly in place.



## GAS CONVERSION

10. Lift the pilot assembly into the fireplace which will give you access to the fittings under the pilot assembly. Take extra caution to not damage ceramic electrode on pilot assembly.



11. Using a 10mm wrench, remove the pilot gas line and swap the pilot orifice with the one supplied in the conversion kit. Be sure that the pilot orifice is fully seated and the pilot gas line is tightened properly to prevent leaks around the orifice. If not seated properly this will cause an unusually high pilot flame.

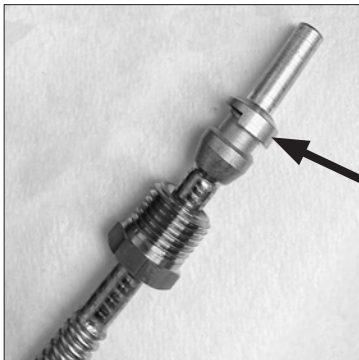

Pilot orifice correctly seated

12. Once the pilot gas line is tightened, reinstall the pilot assembly in the fireplace using the two #10 sheet metal screws provided. Ensure pilot gasket is intact.
13. Reinstall burner and media into fireplace with #10 sheet metal screws from the bottom that you removed in step 5.

## GAS FLOW ADJUSTMENT

It is required you adjust the gas valve when converting the fireplace.

1. Locate and remove the pressure conversion brass plug and set it for NG or LP accordingly. Reinstall and tighten.

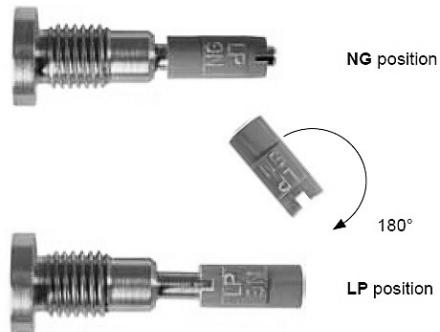

## GAS CONVERSION

2. Confirm inlet pressure of gas (right pressure tap on valve) is between 5.5" w.c./1.4kPa to 10.0" w.c./2.5kPa for natural gas and 11" w.c./2.8kPa to 13" w.c./3.3kPa for propane. If pressure is not within these parameters, correct any gas supply pressure issue before continuing with conversion. Close the pressure tap.



3. Install a pressure gauge on the outlet pressure tap on the valve.
4. Light the fireplace using the remote control.
5. With the fireplace set on the highest flame level, set the high manifold pressure by adjusting the small flat screw set within the brass pressure conversion plug. Refer to the chart below for high pressure settings which vary per model fireplace.



6. With the fireplace set on the lowest flame level, set the low manifold pressure by adjusting the 4mm allen screw on the bottom side of the valve. Refer to the chart below for low manifold pressure settings which vary per model fireplace.

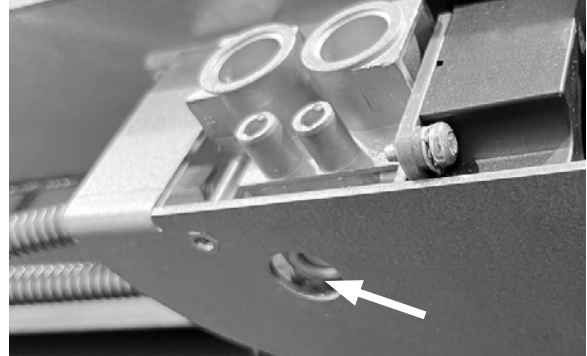

7. Ensure all pressure taps are closed and check all connections/pressure taps for leaks.

MODEL	HIGH PRESSURE	LOW PRESSURE
<b>ONE6 - NG</b>	4.8" w.c. / 1.2kPa	2.2" w.c. / 0.6kPa
<b>ONE6 - LP</b>	10.0" w.c. / 2.5kPa	3.1" w.c. / 0.8kPa

# GAS CONVERSION

## GAS CONVERSION LABEL INSTRUCTIONS

- When converting this fireplace, use a permanent marker to complete the supplied gas conversion label then affix it to the right side of fireplace above the control module as pictured below.



**SÓLAS**

**This fireplace has been converted in the field. This label must be filled out with indelible ink and affixed in a conspicuous location near the appliance listing label.**

Appliance Model: \_\_\_\_\_ Converted to:  NG  LP

Gas Conversion Kit No. \_\_\_\_\_

This Appliance was Converted on (MM/DD/YYYY): \_\_\_\_\_

This Gas Conversion was Completed by: \_\_\_\_\_

Address: \_\_\_\_\_

**CAUTION:**  
This gas conversion must be completed by a licensed gas installer.

Manufactured by: Progressive Manufacturing Inc., 452 Sunapee St., Newport, NH 03773 USA

- Affix the supplied rating plate conversion label to the rating plate. Be sure to not cover the Model and Gas Pressure information for the model and fuel you are converting to. With a permanent marker, check off the fuel type you are converting to.

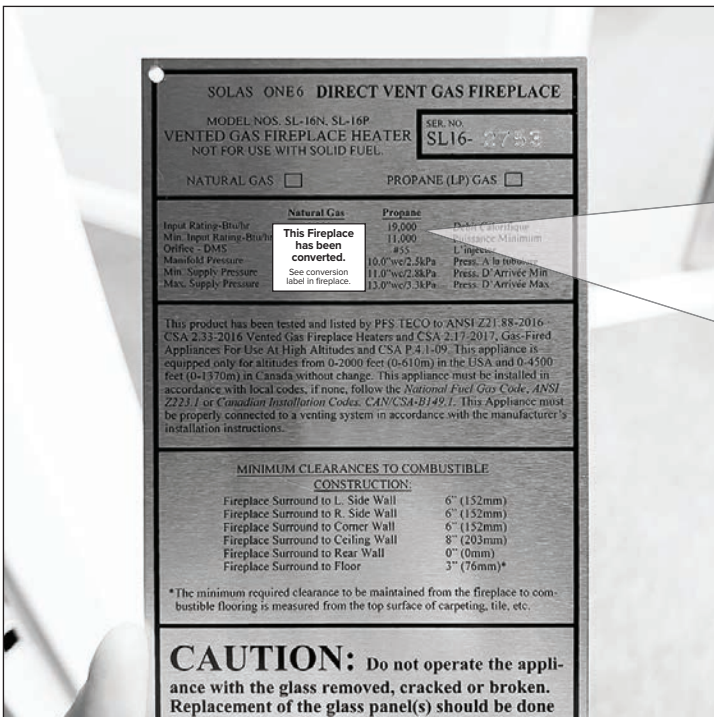

**This Fireplace  
has been  
converted.**

See conversion  
label in fireplace.

## ANNUAL MAINTENANCE

A licensed service agency should conduct an annual inspection and maintenance of your SÓLAS Gas Fireplace including the overall installation and venting to keep it running safely. The following procedures should be performed only by a licensed service technician. The gas supply should be turned off and the stove should be completely cool whenever a maintenance procedure is performed. All parts of the appliance that are removed for servicing must be replaced prior to operation.

**This appliance should be inspected before use and at least annually by a licensed service technician. More frequent cleaning may be required due to excessive dust or lint from carpeting, bedding materials, pets, etc. It is imperative that control compartments and circulating air passageways of this appliance be kept clean.**

## CLEANING THE BURNER & FIREBOX

During the annual inspection and maintenance appointment, the service technician should clean the burner and firebox. To gain access to the firebox and burner, reverse steps 1-6 on page 35 of this manual.

### **DO NOT USE A VACUUM CLEANER TO CLEAN THE GLASS BURNER MEDIA.**

A vacuum cleaner may be used to clean the metal parts of the firebox. Leave the glass burner media in place.

**Use a soft brush to clean the burner glass media.** If the burner media does need to be removed, carefully scoop it off the burner and avoid dropping glass pieces in the air gaps around the burner. Follow the instructions on pages 35 and 36 of this manual when replacing the burner media on the burner top.

After service is complete, replace front glass panel and frame, following steps 1-6 on page 35 of this manual.

## AIR FLOW

The SÓLAS Gas Fireplace utilizes a convection air heat exchange system to maximize heat delivered from the fireplace. It is important that air flows freely through the convection air system and out the air grills. Do not place objects against the fireplace that will block the convection air inlet flow or in front of any air outlet.

## CLEANING GLASS AND PORCELAIN ENAMEL PANELS

**WARNING: Never clean the Glass or Enamel Panels while they are hot. Do not use abrasive cleaners or cleaners containing ammonia.**

When the fireplace is first operated, there may be some vapors and a visible white film left on the glass and panels. This white film, a mineral deposit, is a normal by-product of the combustion process in a gas appliance. The composition of the deposit varies with location and time and is believed to be associated with varying sulfur content in the gas. You may experience this problem intermittently.

We have consulted with ceramic glass manufacturers and they cannot offer a definitive solution to the issue. The following are recommendations only and are not meant to guarantee results. NOTE: This is an issue beyond SÓLAS's control and is not covered under warranty.

- Clean the glass and porcelain enamel panels regularly as soon as you notice a white film build-up. If the film is left for a longer period of time it will etch into the glass and may be harder or impossible to remove.
- NEVER use an abrasive cleaner or an Ammonia-based cleaner on the ceramic glass. An abrasive cleaner will compromise the strength of the glass, An emulsion type cleaner is recommended.
- Use a damp, soft micro-fiber cloth or cotton cloth to apply the cleaner. Dry glass with a soft, dry cloth. (Paper towels and synthetic materials are abrasive to ceramic glass and should not be used)
- We have had good results from the following products, however we cannot guarantee results; Brasso, Polish Plus by Kel-kem, Cook Top Clean Creme by Elco, White Off by Rutland, Turtle Wax.
- **DO NOT CLEAN GLASS WHILE IT IS HOT!**

**NOTE: The batteries in your SÓLAS One-Touch remote control and control module are to be replaced annually. Only use brand name alkaline batteries such as Duracell or Energizer.**

## BATTERY REPLACEMENT

### CONTROL MODULE BATTERIES

Inside your fireplace, there are (4) AA batteries installed inside of the control module.

Frequent beeps for 3 seconds when the motor turns indicates the batteries inside the Control Module are low.

1. Remove surround from Fireplace. Reversing steps as shown on pages 37-38.
2. Loosen silver thumb screw located on the top right side of the control module.



3. Slide the control module assembly up and to the left as shown.



4. The cover on the control module slides up, exposing the (4) AA batteries. Replace with (4) AA alkaline batteries, making sure the battery orientation is correct. SÓLAS recommends using a name brand battery such as Duracell or Energizer.



5. Replace the battery cover, slide control module back into the fireplace and tighten silver thumb screw.
6. To reinstall the Fireplace surround, follow the steps on page 37-38.

### SÓLAS ONE-TOUCH REMOTE BATTERIES

Your remote display will indicate when the batteries are low .

The remote uses (2) AAA alkaline batteries— when replacing, be sure the battery orientation is correct. SÓLAS recommends using a name brand such as Duracell or Energizer.

The batteries should last one full season, depending on usage.

Remove the batteries in the off-season to extend battery life.



## MAINTENANCE LOG

We strongly recommend that you keep a log of the regular maintenance that is performed on your SÓLAS fireplace. We have provided the maintenance form below to make it easy. Simply ask your licensed service technician to fill out one of the maintenance record forms below each time the fireplace is serviced. This will help insure that all of the required maintenance procedures have been completed, at least annually. Regular maintenance will help keep the fireplace functioning in a safe and reliable manner. Additional forms are available from your installer or service technician when needed.

**Date of Service:** \_\_\_\_\_

**Serviced By:** \_\_\_\_\_

**Service Performed:**

- Clean Burner & Firebox
- Clean Control Area
- Clean Convection Air System
- Leak Test Gas Connections
- Replace Batteries in Control Module & Remote
- Clean Firebox Panels and Glass
- Other \_\_\_\_\_

**Date of Service:** \_\_\_\_\_

**Serviced By:** \_\_\_\_\_

**Service Performed:**

- Clean Burner & Firebox
- Clean Control Area
- Clean Convection Air System
- Leak Test Gas Connections
- Replace Batteries in Control Module & Remote
- Clean Firebox Panels and Glass
- Other \_\_\_\_\_

**Date of Service:** \_\_\_\_\_

**Serviced By:** \_\_\_\_\_

**Service Performed:**

- Clean Burner & Firebox
- Clean Control Area
- Clean Convection Air System
- Leak Test Gas Connections
- Replace Batteries in Control Module & Remote
- Clean Firebox Panels and Glass
- Other \_\_\_\_\_

**Date of Service:** \_\_\_\_\_

**Serviced By:** \_\_\_\_\_

**Service Performed:**

- Clean Burner & Firebox
- Clean Control Area
- Clean Convection Air System
- Leak Test Gas Connections
- Replace Batteries in Control Module & Remote
- Clean Firebox Panels and Glass
- Other \_\_\_\_\_

**Date of Service:** \_\_\_\_\_

**Serviced By:** \_\_\_\_\_

**Service Performed:**

- Clean Burner & Firebox
- Clean Control Area
- Clean Convection Air System
- Leak Test Gas Connections
- Replace Batteries in Control Module & Remote
- Clean Firebox Panels and Glass
- Other \_\_\_\_\_

**Date of Service:** \_\_\_\_\_

**Serviced By:** \_\_\_\_\_

**Service Performed:**

- Clean Burner & Firebox
- Clean Control Area
- Clean Convection Air System
- Leak Test Gas Connections
- Replace Batteries in Control Module & Remote
- Clean Firebox Panels and Glass
- Other \_\_\_\_\_



## REPLACEMENT PARTS LIST

PART NAME	P/N	PART NAME	P/N
Pilot Head NG/LP	26-501	#53 Burner Orifice (NG)	16N-509
Pilot Thermocouple*	M26-502*	#58 Burner Orifice (LP)	16P-509
#35 Pilot Orifice (NG)	16N-503	Burner Glass Media – Clear	16-511
#27 Pilot Orifice (LP)	16P-503	Burner Module (NG)	16N-901
SÓLAS One-Touch Control Module	S-504	Burner Module (LP)	16P-901
Wall Touch Pad** (Optional)	WTP-1500	Firebox Panel – Rear	16-512
SÓLAS One-Touch Remote	S-507	Firebox Panel – Left	16-513
Gas Valve (Maxitrol)	M46-515	Firebox Panel – Right	216-514
TC Line Red	M46-701	Thermocouple Interrupter Block	M46-703
TC Line Yellow	M46-702	8-Wire Connecting Cable	M46-704
		Glass Assy (including gasket & frame)	16-510

\*This is a quick response thermocouple. Replace it only with SÓLAS Part Number M26-502.

\*\*Not Compatible with SÓLAS Self-Calibrating Power Vent Kit

**For Replacement Parts and customer service,  
contact your SÓLAS Dealer or;**

**SÓLAS, LLC**

452 Sunapee Street, Newport, NH 03773

P (603) 298-5169 sales@solasfires.com

# CONTROL SCHEMATIC

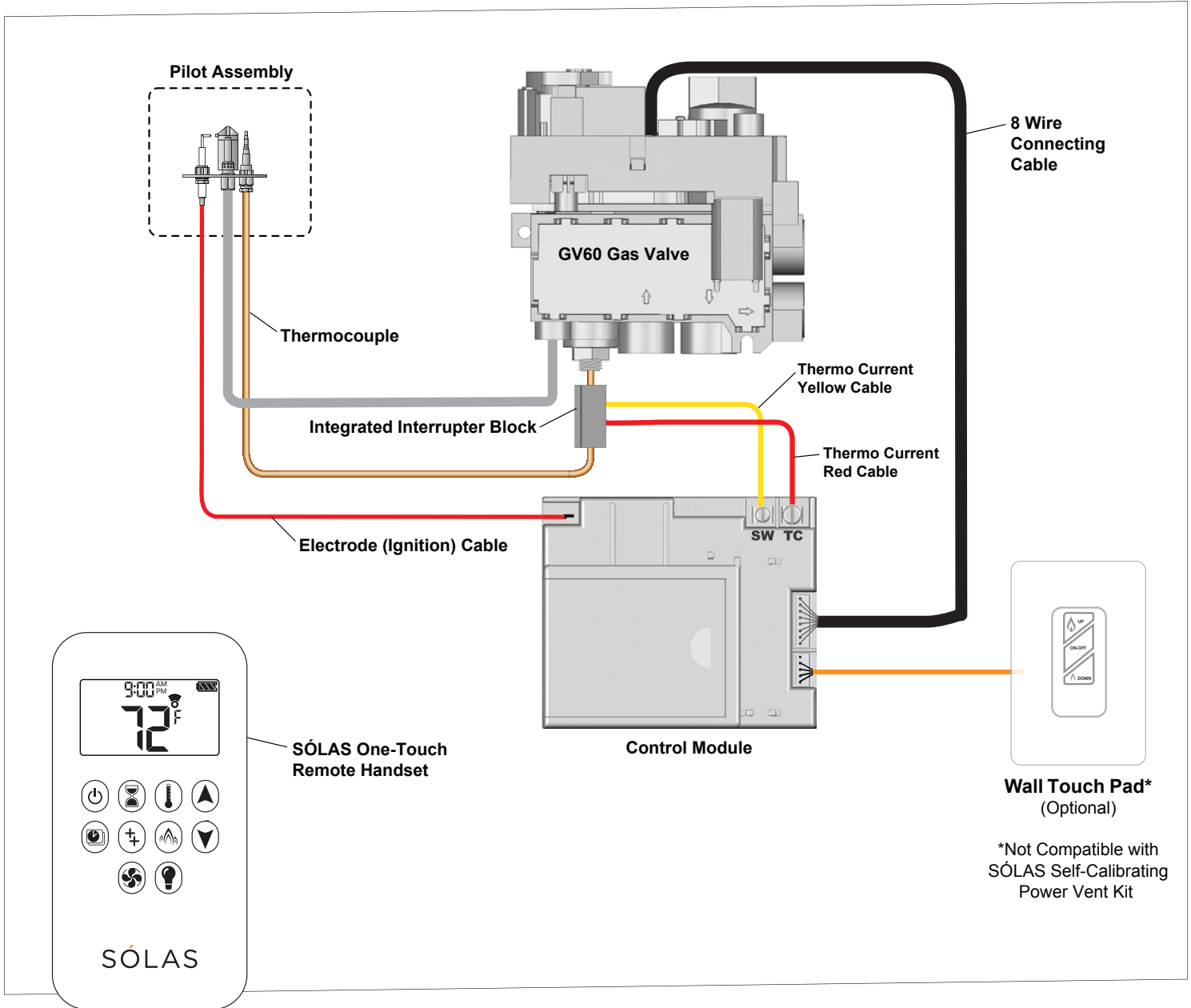

**Wall Touch Pad\***  
(Optional)

\*Not Compatible with  
SÓLAS Self-Calibrating  
Power Vent Kit

## Caution

Label all wires prior to disconnection when servicing the controls. Wiring errors can cause improper and dangerous operation. Verify proper operation after servicing.

# SÓLAS

For Replacement Parts and customer service,  
contact your SÓLAS Dealer or;

**SÓLAS, LLC**

452 Sunapee Street, Newport, NH 03773

P (603) 298-5169 sales@solasfires.com

# WARRANTY INFORMATION

## THE WARRANTY

SÓLAS, LLC, a division of Progressive Manufacturing, Inc. ("SÓLAS"), Limited Lifetime Warranty warrants your SÓLAS brand gas fireplace ("Product") to be free from defects in materials and workmanship at the time of manufacture. The Product body and firebox carry the Limited Lifetime Warranty on workmanship defects causing loss of structural integrity. Ceramic glass carries the Limited Lifetime Warranty against thermal breakage only. After installation, if covered components manufactured by SÓLAS are found to be defective in material or workmanship during the Limited Lifetime Warranty period and while the Product remains at the site of the original installation, SÓLAS will, at its option, repair or replace the covered components. If repair or replacement is not commercially practical, SÓLAS will, at its option, refund the purchase price or wholesale price of the SÓLAS product, whichever is applicable. SÓLAS will also pay their prevailing labor rates, as determined in its sole discretion, incurred in repairing or replacing such components during the warranty period. THERE ARE EXCLUSIONS AND LIMITATIONS to this Limited Lifetime Warranty as described herein.

## COVERAGE COMMENCEMENT DATE

Warranty coverage begins on the date of installation. The warranty shall commence no later than 24 months following the date of product shipment from SÓLAS, regardless of the installation date.

## EXCLUSIONS AND LIMITATIONS

This Limited Lifetime Warranty applies only if the Product is installed in the United States or Canada and only if operated and maintained in accordance with the printed instructions accompanying the Product and in compliance with all applicable installation and building codes and good trade practices.

This warranty is non-transferable and extends to the original owner only. The Product must be purchased through a listed supplier of SÓLAS and proof of purchase must be provided. The Product body and firebox carry the Limited Lifetime Warranty. The following do not carry the Limited Lifetime Warranty, but are warranted as follows:

- **Burner** – Repair or replacement for three years from date of installation.
- **Gas components & electrical components** – Repair or replacement for one year from date of installation.
- **Blowers & remote controls** – Repair or replacement for one year from the date of installation.
- **Porcelain Firebox Liners** – Replacement for one year against cracking or breakage due to thermal stress from date of installation. Excludes surface and hairline cracks and scratches or slight color changes that do not affect the operation or safety of the unit.
- **Gaskets** – Repair or replacement for one year from the date of installation.
- **Surrounds** – Replacement for one year against cracking or breakage due to thermal stress. Excludes surface and hairline cracks and scratches or slight color changes that do not affect the operation or safety of the unit.
- **Labor coverage** – Prevailing SÓLAS rates apply for the warranty period of the component. SÓLAS will not be liable for travel costs for service work.

SÓLAS will not be responsible for: (a) damages caused by normal wear and tear, accident, riot, fire, flood, or acts of God; (b) damages caused by abuse, negligence, misuse, or unauthorized alteration or repair of the Product affecting its stability or performance. The Product must be subjected to normal use. The product is designed to burn either natural or propane gas only. Burning conventional fuels such as wood, coal or any other solid fuel will cause damage to the Product, will produce excessive temperatures and could result in a fire hazard. (c) Damages caused by failing to provide proper maintenance and service in accordance with the instructions provided with the Product; (d) damages, repairs or inefficiency resulting from faulty installation or application of the Product.

Discoloration and some minor expansion, contraction, or movement of certain parts and resulting noise is normal and not a defect, and, therefore, not covered under warranty. The installer must ensure the appliance is burning as per the rating tag at the time of installation. Over-firing (operation above the listed BTU rate) of this appliance can cause serious damage and will nullify this warranty.

This warranty is void if:

- The unit has been operated in atmospheres contaminated by chlorine, fluorine or other damaging chemicals.
- The unit is subject to submersion in water or prolonged periods of dampness or condensation.
- Any damage to the unit, combustion chamber, heat exchanger or other components due to water or weather damage which is the result of, but not limited to improper chimney/venting installation.

Damage to stainless steel, gold, nickel or porcelain enameled surfaces caused by fingerprints, scratches, melted items, or other external sources left on these surfaces from the use of cleaners is not covered in this warranty.

SÓLAS is not responsible for inadequate fireplace system draft caused by air conditioning and heating systems, mechanical ventilation systems, or general construction conditions which may generate negative pressure in the room in which the appliance is installed. Additionally, SÓLAS assumes no responsibility for drafting conditions caused by venting configurations, adjoining trees or buildings, adverse wind conditions or unusual environmental factors and conditions that affect the operation of the unit.

This Limited Lifetime Warranty covers only parts and labor as provided herein. In no case shall SÓLAS be responsible for materials, components, or construction, which are not manufactured or supplied by SÓLAS or for the labor necessary to install, repair, or remove such materials, components, or construction. Additional utility bills incurred due to any malfunction or defect in equipment are not covered by this warranty. All replacement or repair components will be shipped F.O.B. from the nearest stocking SÓLAS facility.

## LIMITATION ON LIABILITY

It is expressly agreed and understood that SÓLAS' sole obligation and the purchaser's exclusive remedy under this warranty, under any other warranty, expressed or implied, or in contract, tort or otherwise, shall be limited to replacement, repair, or refund, as specified herein.

In no event shall SÓLAS be liable for any incidental or consequential damages caused by defects in the Product, whether such damage occurs or is discovered before or after repair or replacement, and whether such damage is caused by SÓLAS' negligence. SÓLAS has not made and does not make any representation or warranty of fitness for a particular use or purpose, and there is no implied condition of fitness for a particular purpose.

SÓLAS makes no expressed warranties except as stated in this Limited Lifetime Warranty. The duration of any implied warranty is limited to the duration of this expressed warranty.

No one is authorized to change this Limited Lifetime Warranty or to create for SÓLAS any other obligation or liability in connection with the Product. Some states and provinces do not allow the exclusion or limitation of incidental or consequential damages, so the above limitations or exclusions may not apply to you. The provisions of this Limited Lifetime Warranty are in addition to and not a modification of or subtraction from any statutory warranties and other rights and remedies provided by law.

## INVESTIGATION OF CLAIMS AGAINST WARRANTY

SÓLAS reserves the right to investigate any and all claims against this Limited Lifetime Warranty and to decide, in its sole discretion, upon the method of settlement.

To receive the benefits and advantages described in this Limited Lifetime Warranty, the appliance must be installed and repaired by a licensed contractor approved by SÓLAS.

Contact SÓLAS at the address provided herein to obtain a listing of approved dealers/distributors. SÓLAS shall in no event be responsible for any warranty work done by a contractor that is not approved without first obtaining SÓLAS' prior written consent.

## HOW TO REGISTER A CLAIM AGAINST WARRANTY

In order for any claim under this warranty to be valid, you must contact the SÓLAS dealer/distributor from which you purchased the product. If you cannot locate the dealer/distributor, then you must notify SÓLAS in writing. SÓLAS must be notified of the claimed defect in writing within 90 days of the date of failure. Notices should be directed to the SÓLAS Warranty Department. Visit our website at [www.solasfires.com/warranty](http://www.solasfires.com/warranty).

## SÓLAS, LLC

P (603) 298-5169

F (603) 298-9246

[solasfires.com/warranty](http://solasfires.com/warranty)



We recommend that our gas hearth products be installed and serviced by professionals who are certified in the U.S. by the National Fireplace Institute® (NFI) as NFI Gas Specialists. [www.NFICertified.org](http://www.NFICertified.org)

### RECORD YOUR PRODUCT INFORMATION

Model #: \_\_\_\_\_ Serial Number: \_\_\_\_\_

Date Purchased: \_\_\_\_\_ Date Installed: \_\_\_\_\_

THANK YOU FOR CHOOSING  
**SÓLAS**

[solasfires.com](http://solasfires.com)

PROUDLY DESIGNED  
& BUILT IN THE

**USA**